

# NR-32 UniSafe®

## Fingerschutzrollo/Finger protection roller blind/Store anti pince-doigts

Montage an Panikbeschlag/installation on push bar/ Montage sur porte avec barre anti panique

Bitte beachten Sie die alternativen Einbausituationen in den Anwendungsbeispielen. Der Einsatz von Fingerschutz entbindet nicht von der Aufsichtspflicht. Technische Änderungen vorbehalten. Please note the alternative installation situations in the application examples. The use of finger protection does not obviate the duty of supervision. Technical specifications are subject to change. Veuillez noter la situation d'installations alternatives dans les exemples d'application. L'installation de protection anti pince-doigts n'exclut pas le devoir de surveillance. Les spécificités techniques sont susceptibles de changer.

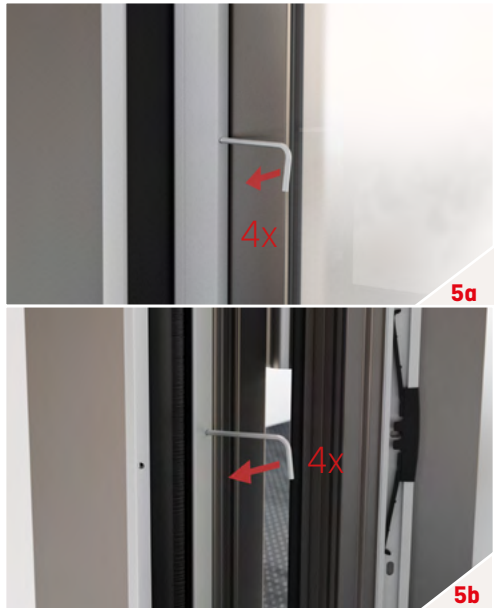
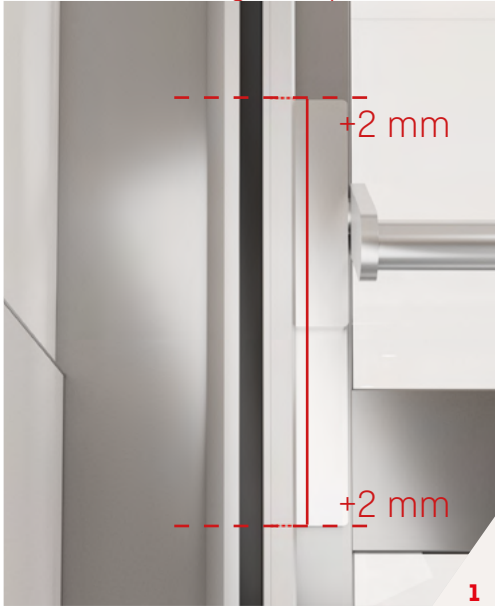

# NR-32 UniSafe®

## Fingerschutzrollo/Finger protection roller blind/Store anti pince-doigts

### Alternative Montage/alternative installation/Montage alternatif

Bitte beachten Sie die alternativen Einbausituationen in den Anwendungsbeispielen. Der Einsatz von Fingerschutz entbindet nicht von der Aufsichtspflicht. Technische Änderungen vorbehalten. Please note the alternative installation situations in the application examples. The use of finger protection does not obviate the duty of supervision. Technical specifications are subject to change. Veuillez noter la situation d'installations alternatives dans les exemples d'application. L'installation de protection anti pince-doigts n'exclut pas le devoir de surveillance. Les spécificités techniques sont susceptibles de changer.

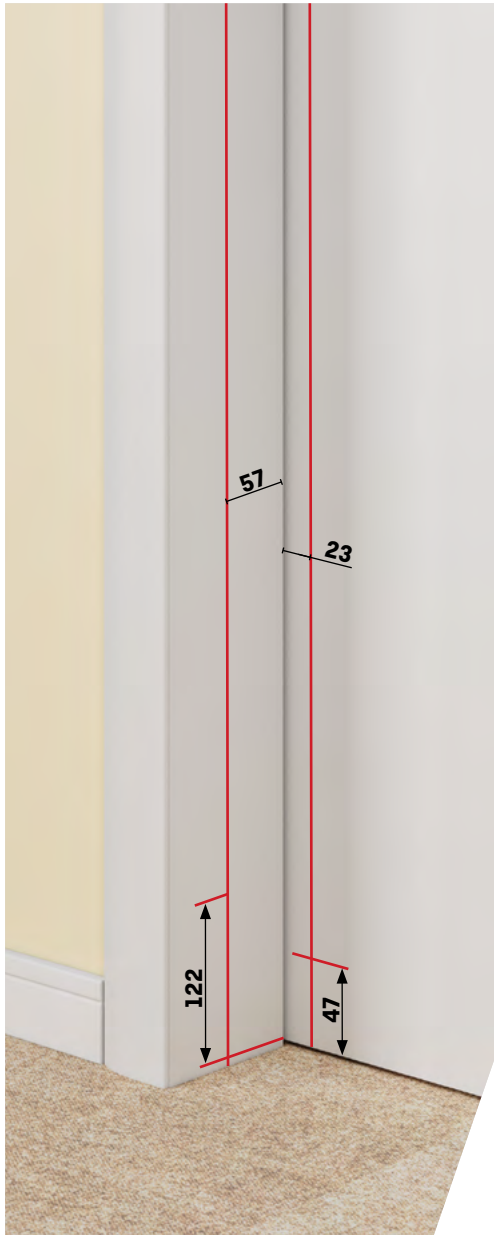

Mindestabstand/minimum distance/écart minimum

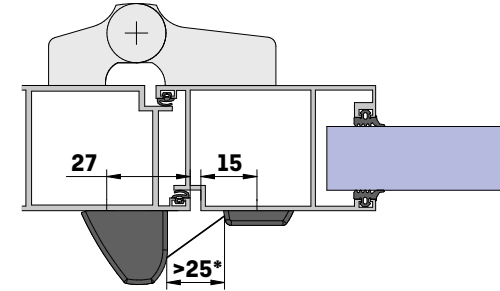
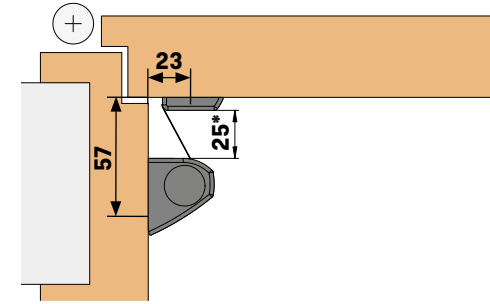

Optional/Option

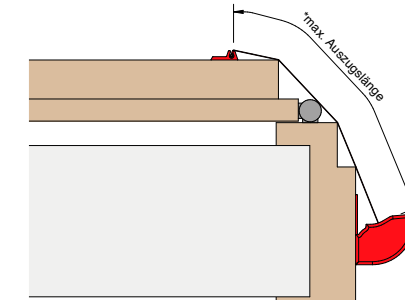

XL-Varainte



für Glasuren/for glass doors/  
pour porte en verre



w-proof - Außenanwendung/for outdoor use/  
Pour porte extérieure

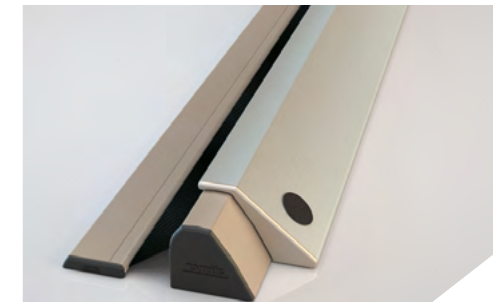

mit Rammschutz/with ram protection/  
avec profil de protection

