



athmer.com

# Product catalogue

MIDDLE EAST / SOUTH ASIA / ASIA / SOUTH EAST ASIA  
2022

**athmer**





GOOD DOORS DESERVE  
FIRST-CLASS SEALS

**GOOD  
CUSTOMERS  
DESERVE  
FIRST-CLASS  
SERVICE**



athmer has been investing significantly throughout Asia and the region is set to continue its growth. The construction industry will play a big part in that, being tasked with building and modernising the cities of tomorrow.

As cities are modernised, there will be greater focus on the technical aspects of doors and high-performance doorsets. Door technology has advanced significantly, whilst regulations and standards continue to improve. We now rightfully view fire doors as “engineered life safety devices” critical to the protection of both life and property. With loud and crowded cities growing in size

and popularity and with studies linking noise to a decrease in overall physical and mental health, acoustic doors now have as essential a role as ever.

Having recently invested in production facilities and sales offices across the region, athmer looks to bring its quality and expertise to a brand new set of customers. As our operations develop we hope to foster strong relationships with our customers, offer a more direct service, reinforce our understanding of the market and implement both a broad and relevant product offering for our customer base.



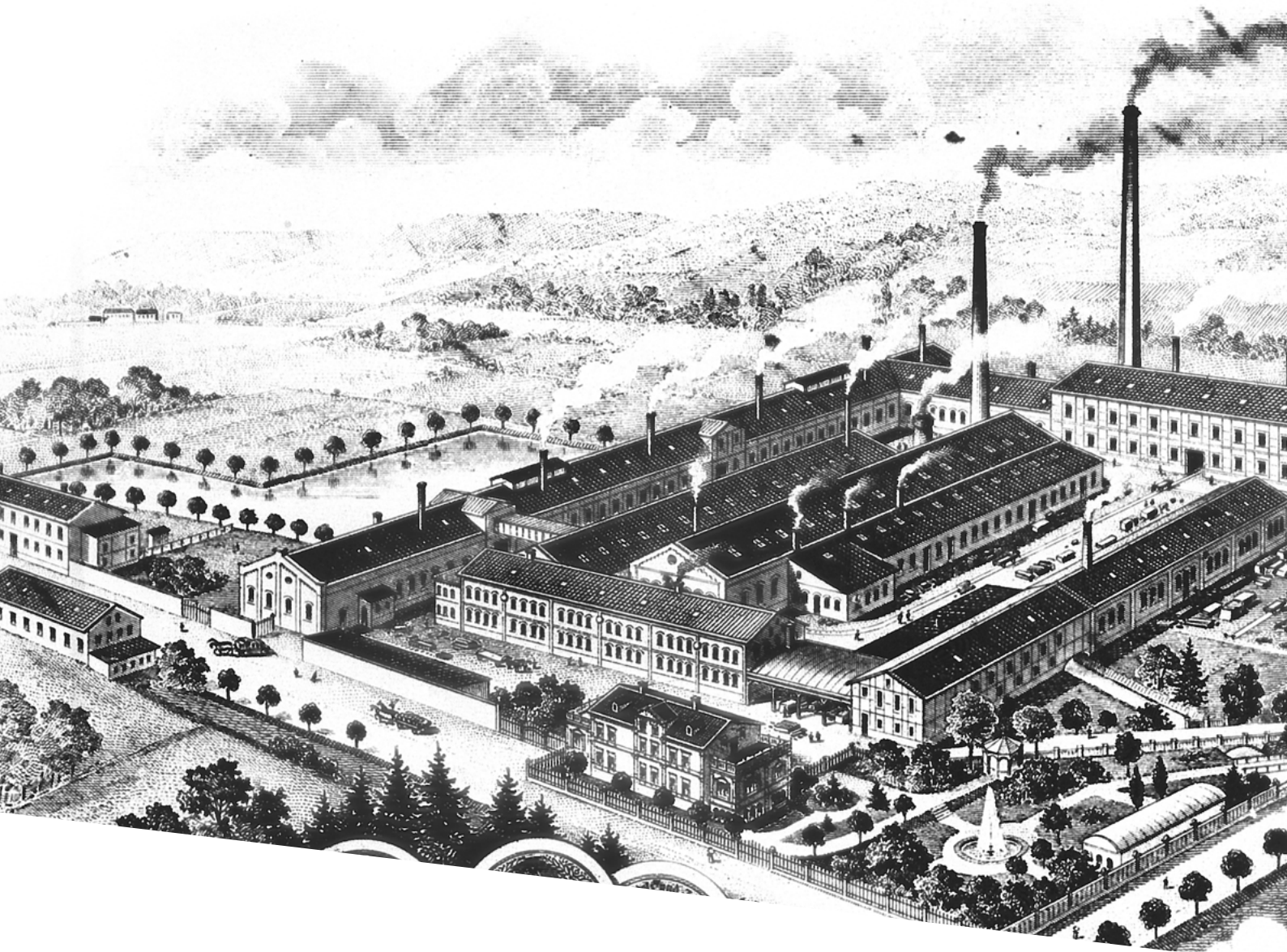

## Responsible and reliable since 1711

athmer has been the leading global specialist in the design and manufacture of high performance sealing and finger protection systems since the 1950's.

From our headquarters in Arnshausen, Germany a continued focus on development and innovation has facilitated our emergence as the premium choice in complete door sealing systems. athmer is part of the JCS (Julius Cronenberg Sophienhammer) group of companies. The group was founded in 1711 and recently celebrated its 300th anniversary. Its headquarters remains on the same site – the old Sophienhammer forge – it purchased in 1870 and its operations have grown sustainably ever since, with the group now incorporating 10 companies.

The family-owned group is now in its 10th generation and first made a name for itself in the late 19th Century

as it developed the first branded scythe, a popular agricultural tool of the period.

The emergence of more modern agricultural techniques in the mid-1950's gave the group an opportunity to diversify into new markets, leading to the registration of the Kaltefeind® brand and the birth of athmer. Today both the Kaltefeind® and Schall-Ex® brands are synonymous with automatic drop seals and athmer has built on this experience by widening its field of expertise to perimeter sealing.

Having made several investments worldwide, we have expanded our operations into the Middle East and throughout South East Asia, including China and India. With a new global presence we hope to offer a more targeted product offering and more personalised service level to the individual regions.





**J C S**

**JULIUS CRONENBERG SOPHIENHAMMER  
OFFENE HANDELSGESELLSCHAFT SEIT 1711**



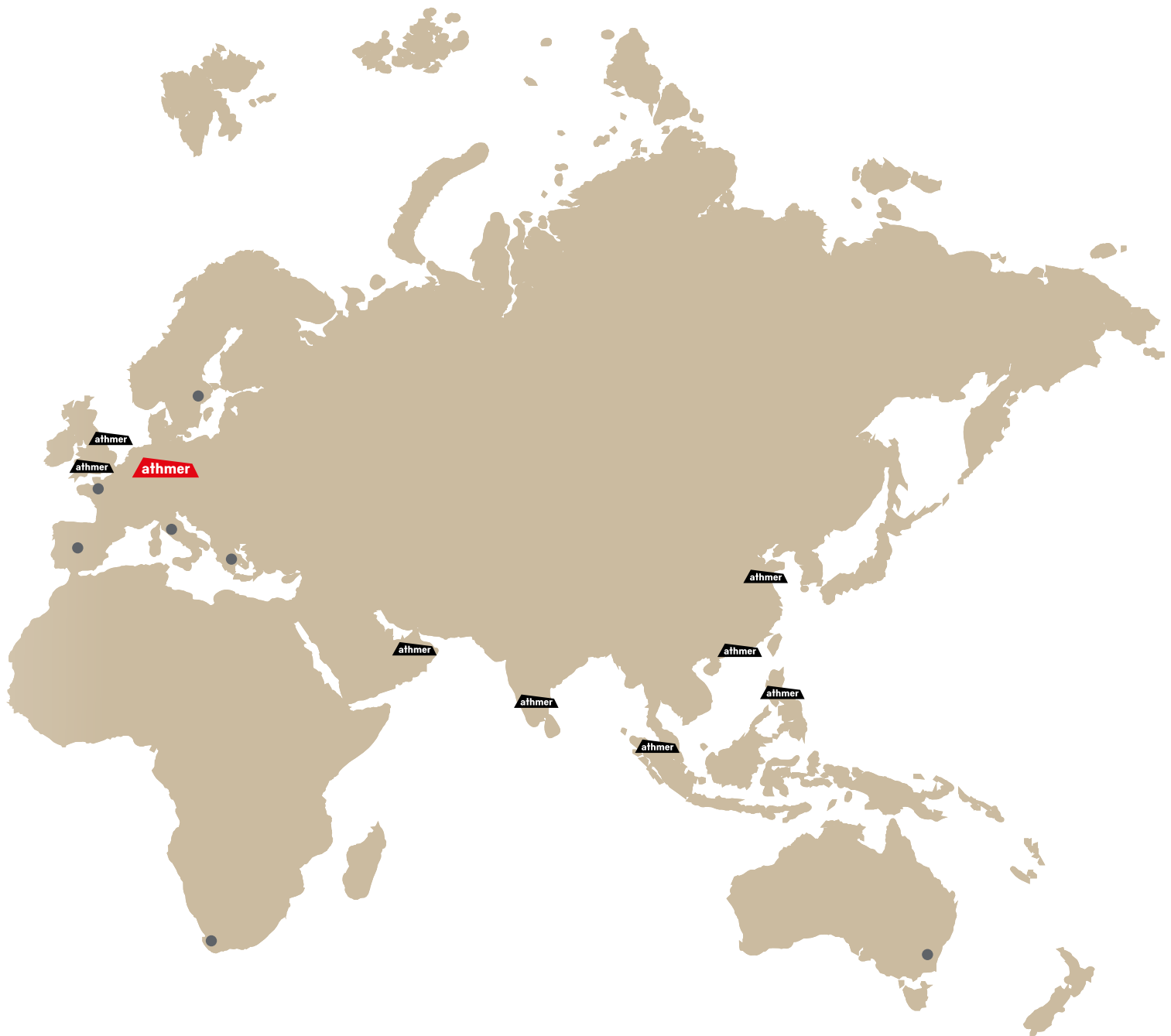

## athmer Group expands its business in Asia

After athmer first gained a foothold in the Asian market in 2015 with the founding of **Qingdao Sophiehammer Hardware Co., Ltd (QSH) in China**, the company continuously expanded its presence in the Middle and Far East in the years that followed. athmer established branches in no less than three growth centers on the Asian continent: in **Singapore**, **India** and **Dubai**.

The most important goal is to establish greater proximity to local customers. On the one hand, the establishment of the branches makes it possible to keep products in central warehouses or at regional distributors and thus make them available more quickly. On the other hand, Asian customers have personal contacts in their region, which simplifies and optimizes service and support. As athmer's expertise relates not only to drop seals but to the entire door system, local employees can provide customers with individual and competent advice - for example with regard to specific standards and requirements. Customers can thus be sure of receiving the right product for their requirements.

# ATHMER - A GROUP OF COMPANIES COMMITTED TO FIND SOLUTIONS

## Competence across the UK

With its commitment in the UK, athmer took another significant step towards internationalization in 2015: The acquisition of **Norseal Ltd.** enabled the exchange of know-how in the field of door seals for special technical doors, from which both companies benefit to this day.

At the beginning of 2022, athmer also took over **Firestop Ltd.** in Dorchester. This enabled the medium-sized company to further differentiate its product portfolio, as Firestop has positioned itself not only as an expert for special door seals, but also for fire protection strips in doors. athmer now sells this additional fire protection solution to customers all over the world and can thus constantly expand its expertise and market position in the field of fire protection doors.





## Quality Made in Germany

For us, quality is an important component of athmer's success, because we produce durable, reliable and therefore sustainable products. Door seals and finger protection systems must meet the highest standards before they are installed. At the same time, we always have a desire for innovation.

This is one reason why we have over 150 patents and utility models worldwide that optimize seals and finger protection. Before a product leaves our company, it is put through its paces. Because only when it meets our high quality standards it's ready for the market and good enough for our customers.

## Research and development

# Traditions that bind. Innovations that change.

When introducing new products, the research and development process is of crucial importance. A thorough development process ensures a smooth product launch and continuous usability. This is highly relevant in today's world, where innovations must be integrated efficiently and without errors.

Thanks to modern technology and the necessary know-how, a whole range of development processes can be carried out in-house. These include 3D modeling, 3D printing and pre-testing of various materials. The key to our success is our ability to adapt to an ever-changing market, which has established us as pioneers in sealing technology.



athmer technical centre

# Sound, air/ wind/water, burglary & hot smoke testing facility

Our state-of-the-art technical centre is, through continuous process optimization, equipped to carry out a number of tests. We test the sound insulation capacity of doors and windows and their resistance to air, driving rain and wind loads. As well as a world class hot smoke testing facility and we are proud to state that it is in association with ift-Germany, a renowned testing institute.

Athmer is Europe's leading manufacturer of automatic door seals and a reliable partner to our customers for more than 60 years. As a part of the legendary JCS group we are highly committed to quality and honour agreements with our customers. We support and offer counsel to our customers in the various stages of the product development with the aim of getting the product onto the market quickly, efficiently and with the highest quality standards.

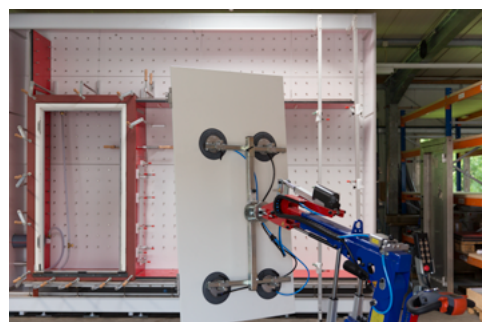
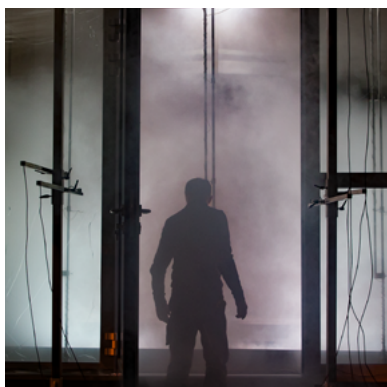



athmer  
technical  
centre

## **athmer technical centre**

### **development & innovation go together at athmer**

We live in an interesting era shaped by constant demand and rapidly changing technology. The world of doors is constantly transforming and evolving. We at athmer are actively involved in adapting to this evolution. The culture of customer focus, adapting to new technologies, new requirements and creating new benchmarks is the driving force for the company's success.

athmer's commitment to providing world class quality products relies on its technical centre, where the highly trained technicians and engineers of the development team use latest technologies, always with the aim of further improving the quality of our door seals and finger protection systems.

More than 150 patents and registered designs worldwide clearly demonstrate our innovative ability. In order to further strengthen and add value to our customers, we collaborate with renowned test institutes and our engineers are proactively engaged in various committees of DIN standards. In this way, we are actively involved in establishing new standards in the world of doors.



# Our commitment quality & sustainability

Athmer is committed to both quality and sustainability and this has been **internationally recognised** by test and certification institutes worldwide. Copies of all certification can be supplied on request.



Wherever you see this logo our products have been evaluated under Warringtonfire's CERTIFIRE scheme. CERTIFIRE is an internationally-recognised, independent third-party certification scheme that assures performance, quality, reliability and traceability of products and systems.



Wherever you see this logo our products have been evaluated under the UL Mark – the most widely recognised and accepted evidence of a product's compliance with U.S. & Canadian safety requirements. The mark is one of the most valued product safety symbols worldwide, including Asia & the Middle East.



Wherever you see this logo our products have been cycle tested by MPA NRW in Germany. MPA NRW is a publically-owned test institute that was founded in 1947 and they have provided us with independent testing as evidence of our seal's durability. MPA's independent verification is another example of our commitment to quality and it supports the extensive and frequent internal testing we conduct on our products.



Wherever you see this logo our products are covered by an Environmental Product Declaration (EPD) in accordance with EN ISO 14025 and EN 15804. The EPD is further evidence of our wider commitment to sustainability and permits our product's use in certified Green Buildings across the world. Additionally, we have developed a CO<sup>2</sup> calculator to help users understand the tangible environmental benefits of fitting Athmer seals to their buildings. You can access it via [co2ool.info](http://co2ool.info).

# Content

CHAPTER	CATEGORY	PAGE
<b>1</b>	<b>Perimeter seals</b>	<b>14</b>
1.1	/ perimeter seals for installation in a groove	16
1.2	/ self-adhesive perimeter seals	32
1.3	/ surface mounted perimeter seals	44
1.4	/ perimeter seals for sliding and pivot doors	52
<b>2</b>	<b>Drop seals</b>	<b>60</b>
2.1	/ rebated drop seals for hinged doors	62
2.2	/ drop seals for sliding doors	112
2.3	/ rebated drop seals for pivot doors	123
2.4	/ drop seals for hinged glass doors	124
2.5	/ drop seals for sliding glass doors	130
2.6	/ surface mounted drop seals	132
<b>3</b>	<b>Flush bolts for drop seals</b>	<b>140</b>
<b>4</b>	<b>Bottom seals</b>	<b>142</b>
<b>5</b>	<b>Intumescent seals &amp; hardware protection</b>	<b>152</b>
5.1	/ graphite intumescent seals	154
5.2	/ Palusol® intumescent seals	160
5.3	/ intumescent hardware protection sheets	164
<b>6</b>	<b>Threshold plates</b>	<b>166</b>
6.1	/ thermally separated thresholds	168
6.2	/ stainless steel & aluminium threshold plates	170
6.3	/ panic thresholds	178
<b>7</b>	<b>Rain drip guard</b>	<b>184</b>
<b>8</b>	<b>Finger protection systems</b>	<b>186</b>
8.1	/ roller blinds	188
8.2	/ protective profiles	190
8.3	/ door stop	206
<b>9</b>	<b>Door opening restrictor</b>	<b>208</b>
<b>10</b>	<b>Indices &amp; information</b>	<b>200</b>
10.1	/ product name index	212
10.2	/ art.no. index	214
10.3	/ installation information	220
10.4	/ glossary of terms	211

## Perimeter seals

# High performance solutions for door frames

Our range of perimeter seals has been curated to offer solutions for a **wide range of gap sizes, fixing locations and applications**. This includes rebated, self-adhesive and surface-mounted options for both door stops and frame reveals. Some seals act as compression seals, shaped so that they compress against the door when it is closed. Others perform as a sweep seal, sweeping against the door edge as the door moves into a closed position.

The athmer range includes seals that can be used at the head, jambs and the meeting stile of doors. There are solutions for hinged and sliding doors as well as for timber, metal and glass surfaces. Their main purpose is to provide an effective barrier against sound transfer between the door and door frame, as well as smoke, air, light, dirt, dust and odours. They can also effectively muffle door closing noise. They are the perfect accompaniment to our range of drop seals and an **essential component in an acoustic door assembly** targeting acoustic performance.





## Perimeter seals

# Schall-Ex® AP 1015 TE

- / door stop-rebated compression seal
- / suitable for sound insulation
- / suitable for smoke sealing



## TECHNICAL DATA

Application	timber frame rebates
Gasket material	TPE
Working temperature range	-40°C to +180°C

## DIMENSIONS

Width x height	12 x 12.5 mm
Fitting tolerance range	4.5 - 5.5 mm
Standard lengths	50m coil

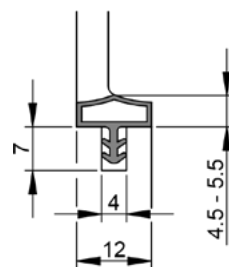
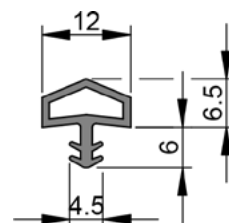

## FIXING

Fixing	into a groove in the door stop
--------	--------------------------------

## COLORS

COLORS	ART.NO.
Black	P160069
Brown	P160071
White	P160072
Beige	P160070

# Schall-Ex® AP 1018 TE

- / door stop-rebated compression seal
- / suitable for sound insulation
- / suitable for smoke sealing

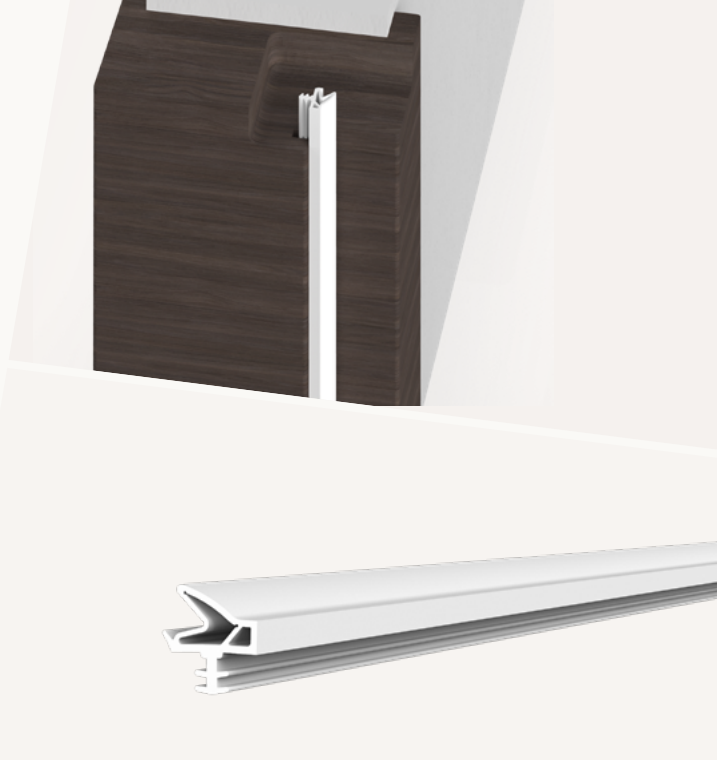

## TECHNICAL DATA

Application	timber frame rebates
Gasket material	TPE
Working temperature range	-40°C to +180°C

## DIMENSIONS

Width x height	12 x 13 mm
Fitting tolerance range	4.5 - 6.5 mm
Standard lengths	25m or 100m coil

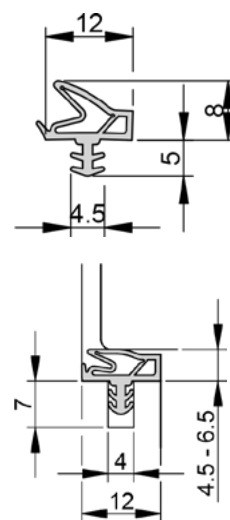

## FIXING

Fixing	into a groove in the door stop
--------	--------------------------------

## PERFORMANCE & CERTIFICATES

Acoustic	49dB with 5mm gap
----------	-------------------

## COLORS

## ART.NO.

Black	P160005
Brown	P160007
White	P160008
Beige	P160006



# Schall-Ex® AP 1018 S

- / door stop-rebated compression seal
- / suitable for sound insulation
- / suitable for smoke sealing



## TECHNICAL DATA

Application	timber frame rebates
Gasket material	silicone
Working temperature range	-60°C to +250°C

## DIMENSIONS

Width x height	12 x 13 mm
Fitting tolerance range	4.5 - 6.5 mm
Standard lengths	2 * 25m coil

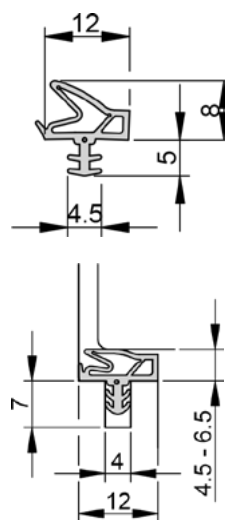

## FIXING

Fixing	into a groove in the door stop
--------	--------------------------------

## PERFORMANCE & CERTIFICATES

Acoustic	49dB with 5mm gap
----------	-------------------

## COLORS

## ART.NO.

Black	P160001
Brown	P160003
White	P160004
Beige	P160002

# Schall-Ex® AP 1019 TE

- / door stop-rebated compression seal
- / suitable for sound insulation
- / suitable for smoke sealing



## TECHNICAL DATA

Application	timber frame rebates
Gasket material	TPE
Working temperature range	-40°C to +180°C

## DIMENSIONS

Width x height	12 x 14 mm
Fitting tolerance range	5 - 7 mm
Standard lengths	25m coil, 150m coil

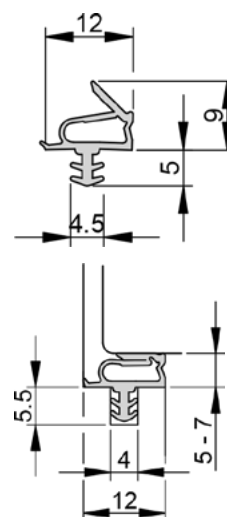

## FIXING

Fixing	into a groove in the door stop
--------	--------------------------------

## PERFORMANCE & CERTIFICATES

Acoustic	50dB with 5mm gap
----------	-------------------

## COLORS

## ART.NO.

Black	P160009
Brown	P160011
White	P160012
Beige	P160010

# PS 2115 S

- / door stop-rebated compression seal
- / suitable for sound insulation
- / suitable for smoke sealing

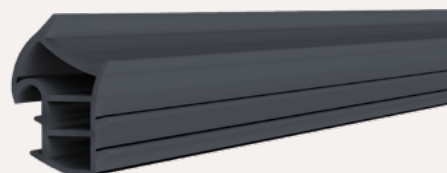

## TECHNICAL DATA

Application	metal frame rebates
Gasket material	silicone
Working temperature range	-40°C to +200°C

## DIMENSIONS

Width x height	12 x 13 mm
Fitting tolerance range	4 - 7 mm
Standard lengths	100m coil

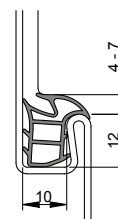
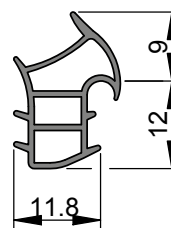

## FIXING

Fixing	into a groove in the door stop
--------	--------------------------------

## PERFORMANCE & CERTIFICATES

Acoustic	49dB with 5mm gap
----------	-------------------

## COLORS

## ART.NO.

Black	P160144
Brown	P160141
White	P160143
Grey	P160142



## PS 0402 S

- / door stop-rebated bubble compression seal
- / suitable for sound insulation
- / suitable for smoke sealing

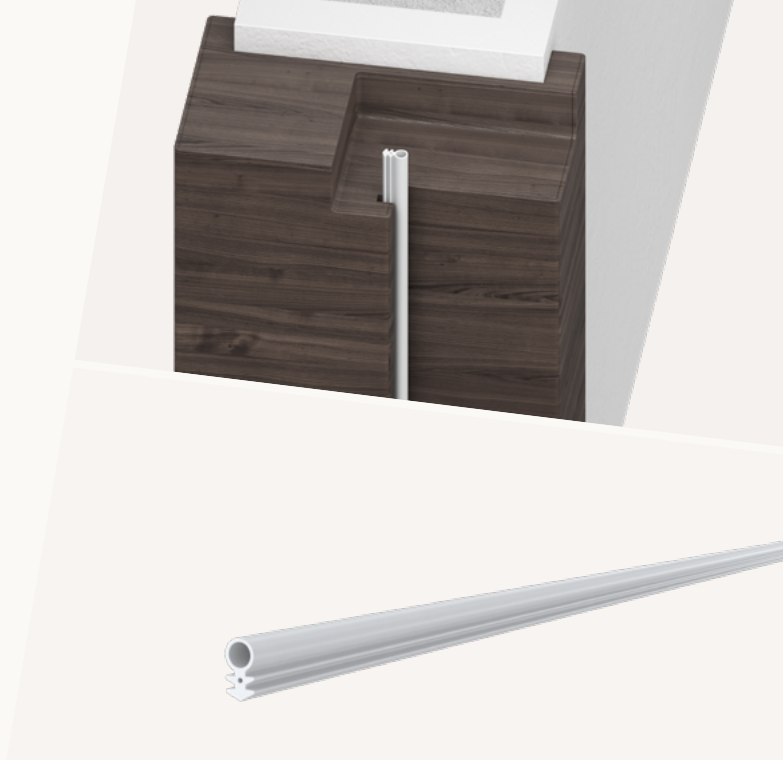

### TECHNICAL DATA

Application	timber frame rebates
Gasket material	silicone
Working temperature range	-60°C to +250°C

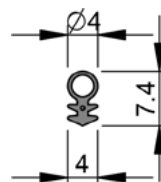

### DIMENSIONS

Width x height	4 x 7.4 mm
Fitting tolerance range	1.5 - 2.5 mm
Standard lengths	100m coil

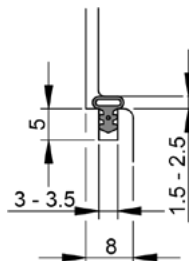

### FIXING

Fixing	into a groove in the door stop
--------	--------------------------------

### COLORS

	ART.NO.
Black	P160027
Brown	P160029
White	P160028

## PS 1206 S

- / door stop-rebated compression seal
- / ensures soft closing of the door
- / suitable for sound insulation & smoke sealing

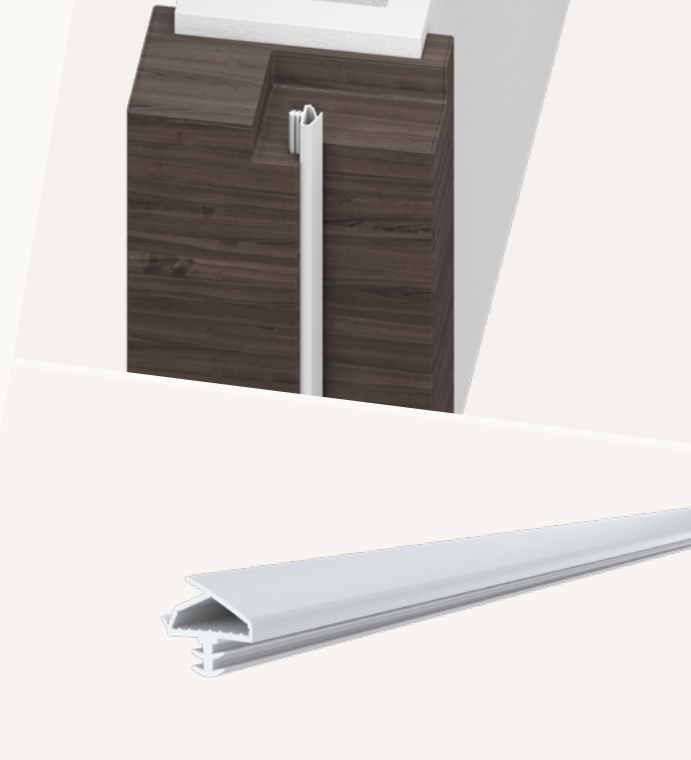

### TECHNICAL DATA

Application	timber frame rebates
Gasket material	silicone, self-extinguishing
Working temperature range	-40°C to +180°C

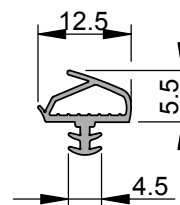

### DIMENSIONS

Width x height	12.5 x 5.5 mm
Fitting tolerance range	3 - 4.5 mm
Standard lengths	100 m coil

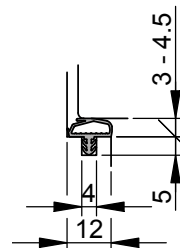

### FIXING

Fixing	into a groove in the door stop
--------	--------------------------------

### COLORS

COLORS	ART.NO.
Black	P160149
White	P160150
Brown	P160221
Dark brown	P160148
Grey	P160222
Cream	P160223

## PS 0704 TE

- / door stop-rebated bubble compressic
- / suitable for sound insulation
- / suitable for smoke protection

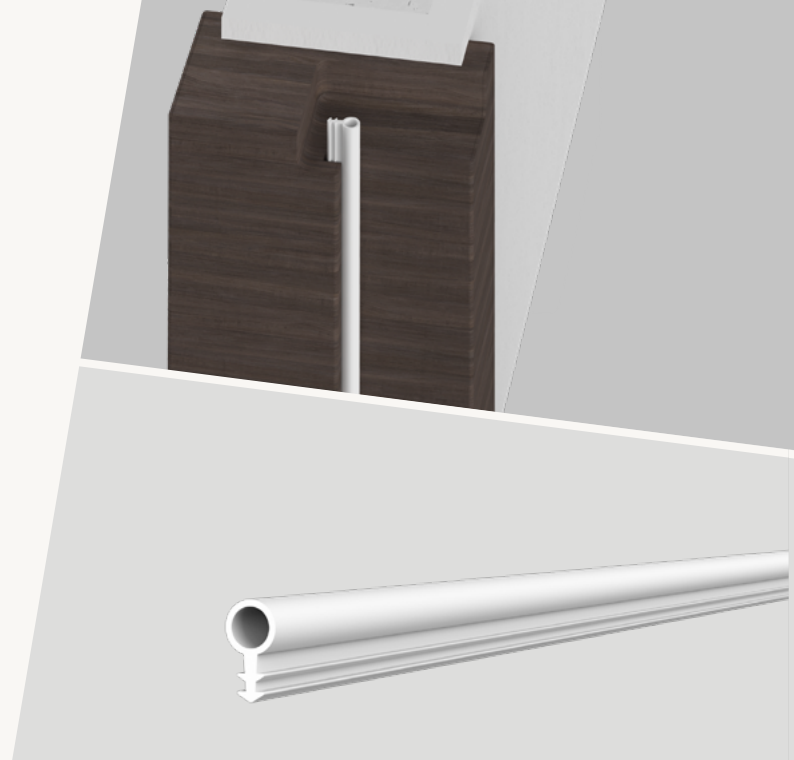

### TECHNICAL DATA

Application	timber frame rebates
Gasket material	TPE
Working temperature	-20°C to +60°C

### DIMENSIONS

Width x height	7 x 12 mm
Fitting tolerance range	4 - 6.5 mm
Standard lengths	250 m coil

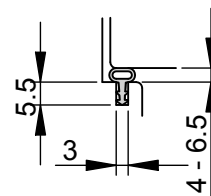
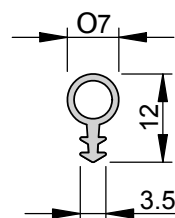

### FIXING

Fixing	into a groove in the door stop
--------	--------------------------------

### COLORS

COLORS	ART.NO.
Dark Brown	P160203
Brown	P160204
Black	P160205
White	P160206
Grey	P160208
Cream	P160207



# PS 0604 S

- / door stop-rebated bubble compression seal
- / suitable for sound insulation
- / suitable for smoke sealing

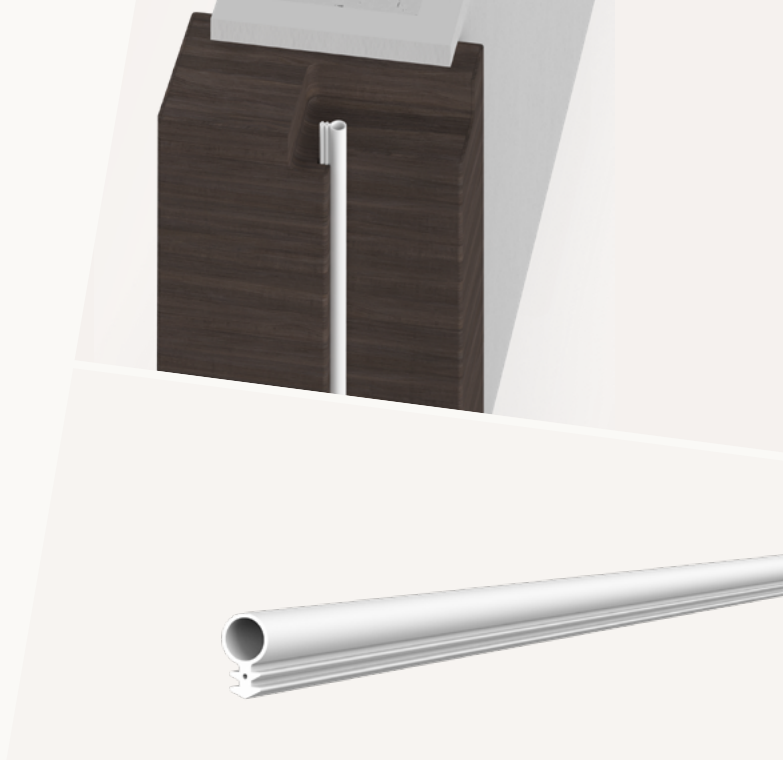

## TECHNICAL DATA

Application	timber frame rebates
Gasket material	silicone
Working temperature range	-60°C to +250°C

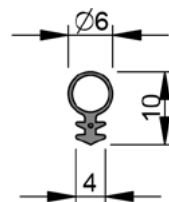

## DIMENSIONS

Width x height	6 x 10 mm
Fitting tolerance range	3 - 5 mm
Standard lengths	100m coil

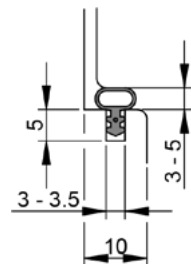

## FIXING

Fixing	into a groove in the door stop
--------	--------------------------------

## COLORS

COLORS	ART.NO.
Black	P160030
Brown	P160032
White	P160031

## Sili II

- / door stop-rebated perimeter seal
- / suitable for sound insulation
- / suitable for smoke protection

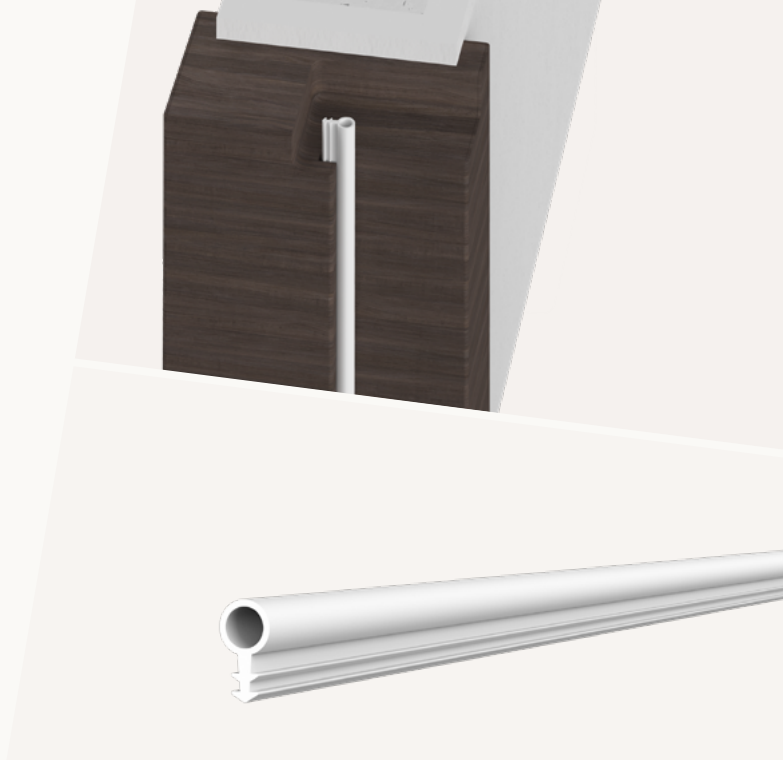

### TECHNICAL DATA

Application	timber frame rebates
Gasket material	flexible PVC

### DIMENSIONS

Width x height	6.5 x 12 mm
Fitting tolerance range	4 - 6 mm
Standard lengths	50m coil

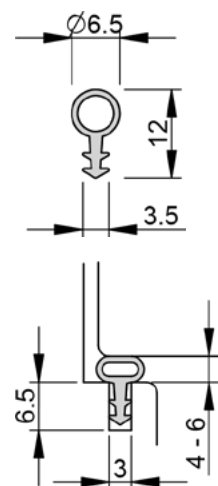

### FIXING

Fixing	into a groove in the door stop
--------	--------------------------------

### COLORS

Transparent

### ART.NO.

150002

# PS 0704 S

- / door stop-rebated bubble compression seal
- / large tolerance compensation
- / suitable for sound insulation
- / suitable for smoke sealing

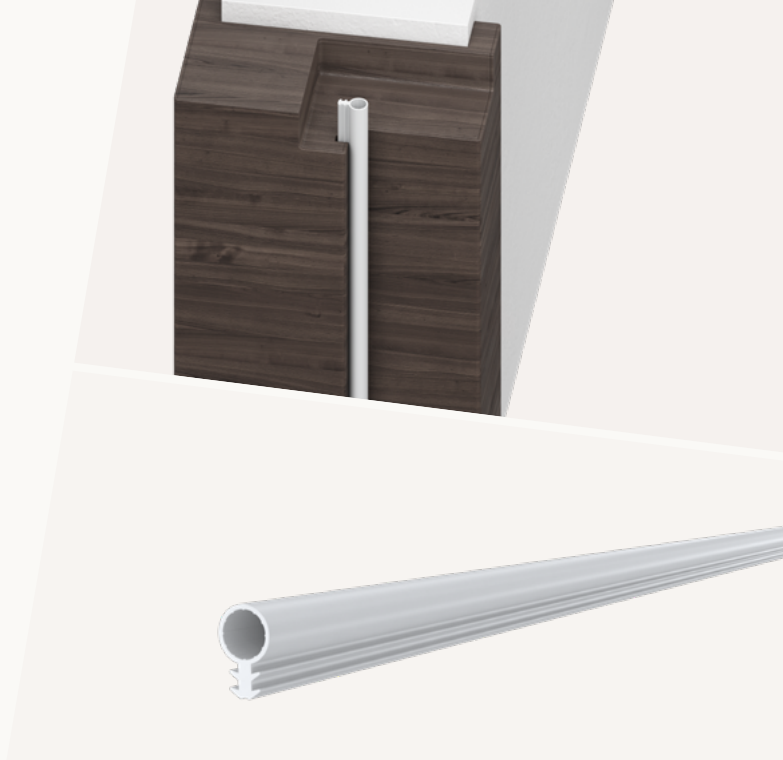

## TECHNICAL DATA

Application	timber frame rebates
Gasket material	silicone, self-extinguishing
Working temperature range	-40°C to +180°C

## DIMENSIONS

Width x height	7 x 11 mm
Fitting tolerance range	1.5 - 6.5 mm
Standard lengths	100m coil

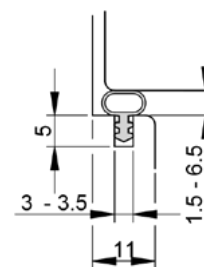
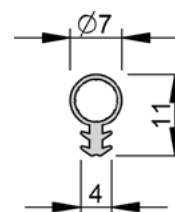

## FIXING

Fixing	into a groove in the door stop
--------	--------------------------------

## PERFORMANCE & CERTIFICATES

Fire	EN1634-1*
------	-----------

## COLORS

## ART.NO.

Black	P160057
Dark brown	P160056
Brown	P160214
White	P160065
Grey	P160080
Cream	P160215

\*The test value may differ according to the EN 1634-1 test, as the complete door system must be checked.



## PS 0805 S

- / door stop-rebated bubble compression seal
- / suitable for sound insulation
- / suitable for smoke sealing

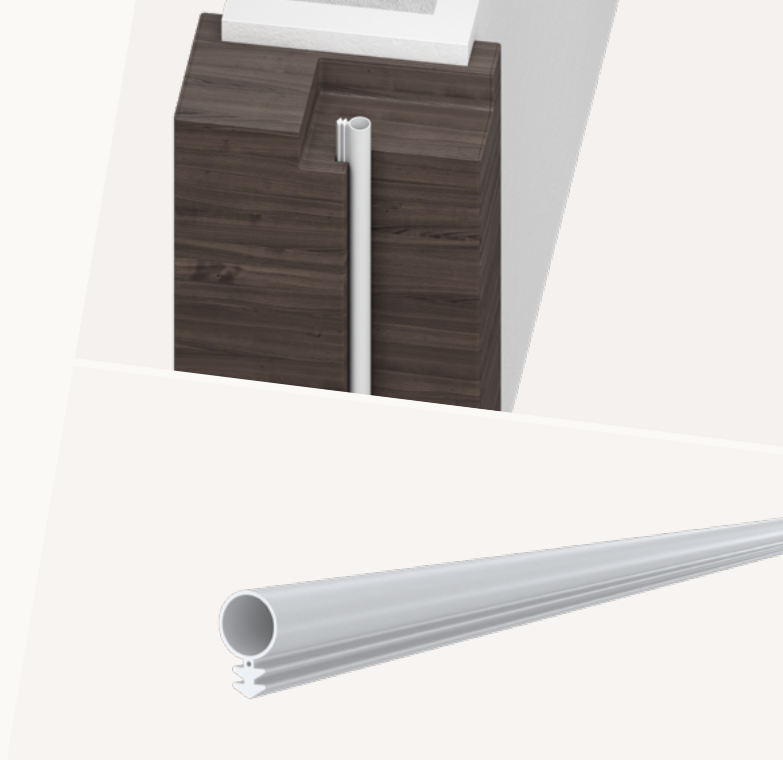

### TECHNICAL DATA

Application	timber frame rebates
Gasket material	silicone
Working temperature range	-60°C to +250°C

### DIMENSIONS

Width x height	8 x 12.5 mm
Fitting tolerance range	4 - 7 mm
Standard lengths	100m coil

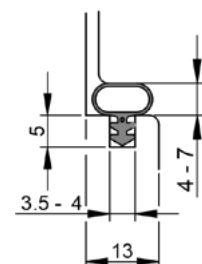
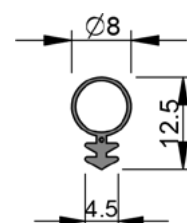

### FIXING

Fixing	into a groove in the door stop
--------	--------------------------------

### COLORS

COLORS	ART.NO.
Black	P160033
Brown	P160035
White	P160034

# PS 3645 P

- / double fin perimeter and meeting stile seal
- / suitable for sound insulation
- / suitable for smoke sealing

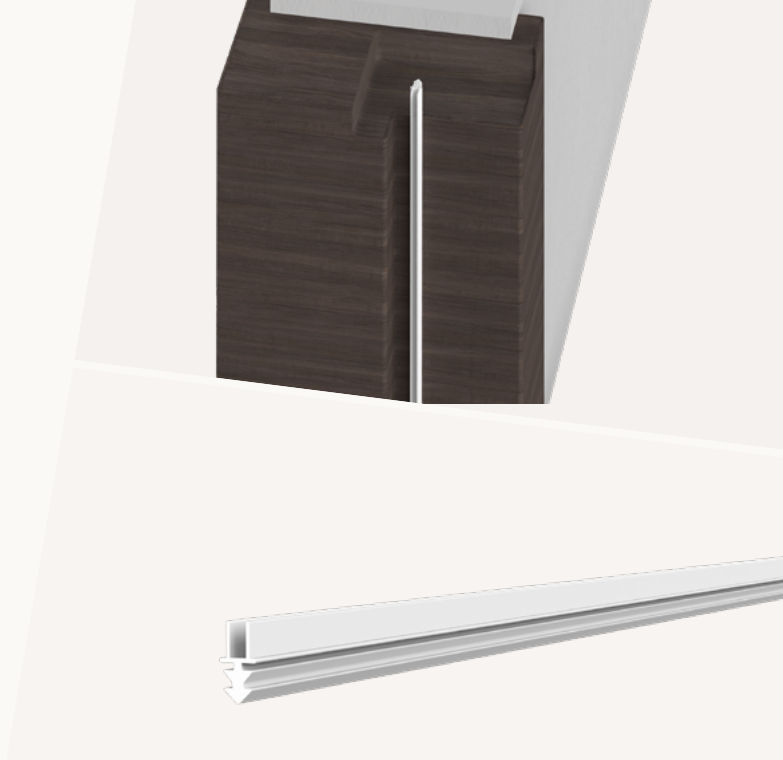

## TECHNICAL DATA

Application	timber frame & door rebates
Gasket material	rigid PVC base, flexible PVC fins
Working temperature range	-20°C to +60°C

## DIMENSIONS

Width x height	3.3 x 8 mm
Fitting tolerance range	2 - 4 mm
Standard lengths	2100, 2400, 3000 mm

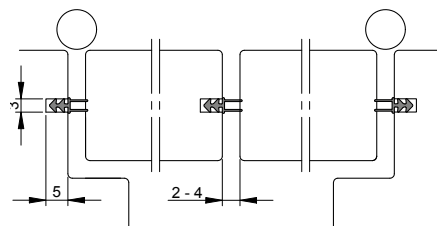
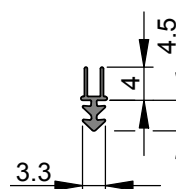

## FIXING

Fixing	into a groove in the door frame or door leaf
--------	--

## PERFORMANCE & CERTIFICATES

Fire	EN1634-1*
------	-----------

## COLORS

COLORS	ART.NO.
Black	P160036
Brown	P160156

\*The test value may differ according to the EN 1634-1 test, as the complete door system must be checked.

# PS 3665 P

- / double fin perimeter and meeting stile seal
- / suitable for sound insulation
- / suitable for smoke sealing

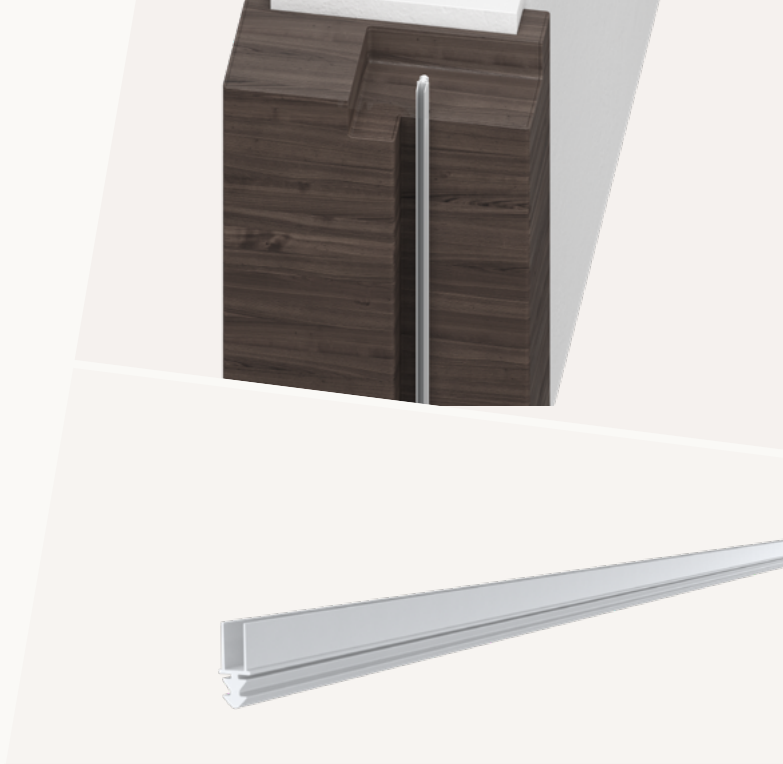

## TECHNICAL DATA

Application	timber frame & door rebates
Gasket material	rigid PVC base, flexible PVC fins
Working temperature range	-20°C to +60°C

## DIMENSIONS

Width x height	3.3 x 10 mm
Fitting tolerance range	4 - 6 mm
Standard lengths	2100, 2400, 3000 mm

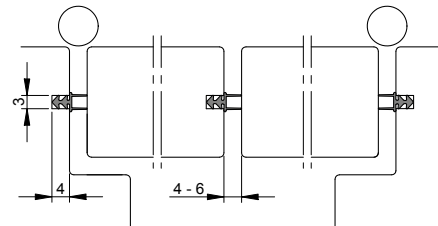
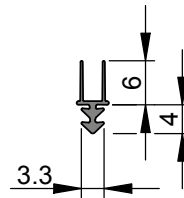

## FIXING

Fixing	into a groove in the door frame or door leaf
--------	--

## PERFORMANCE & CERTIFICATES

Fire	EN1634-1*
------	-----------

## COLORS

COLORS	ART.NO.
Black	P160058
Brown	P160155

1 Perimeter seals  
1.1 perimeter seals for installation in a groove

# ZD Universal

- / door stop-rebated compression seal
- / suitable for sound insulation
- / suitable for smoke sealing

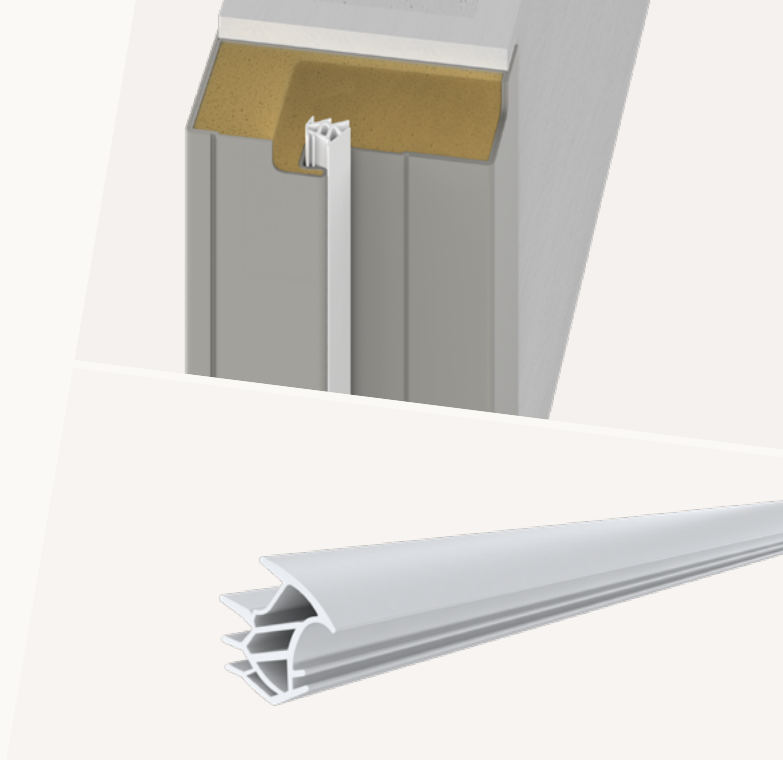

## TECHNICAL DATA

Application	metal frame rebates
Gasket material	TPE

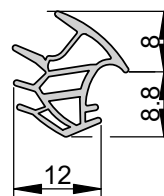

## DIMENSIONS

Width x height	12 x 16.8 mm
Fitting tolerance range	3 - 7 mm
Standard lengths	5m coil, 25m coil

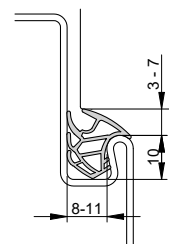

## FIXING

Fixing	into a groove in the door stop
--------	--------------------------------

LENGTHS	ART.NO.
5 m	370300
25 m	371300





## PS 1817 S

- / stop-rebated compression seal
- / suitable for sound insulation
- / suitable for smoke sealing

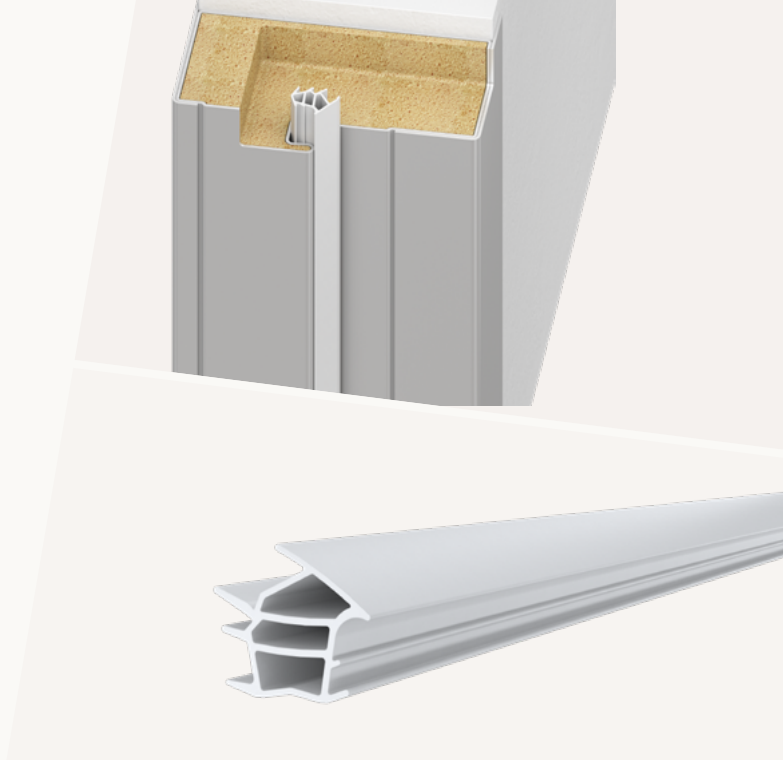

### TECHNICAL DATA

Application	metal frame rebates
Gasket material	silicone, self-extinguishing
Working temperature range	-40°C to +200°C

### DIMENSIONS

Width x height	18 x 18 mm
Fitting tolerance range	3 - 7 mm
Standard lengths	25m coil

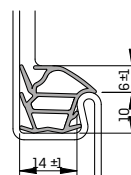
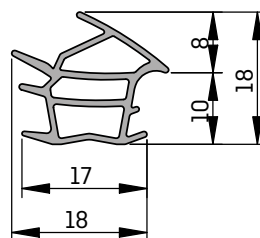

### FIXING

Fixing	into a groove in the door stop
--------	--------------------------------

### PERFORMANCE & CERTIFICATES

UL	UL 10C (R38166)
----	-----------------

### COLORS

### ART.NO.

Black	P160187
Grey	P160145
White	P160188



# PS 788 S

- / frame-mounted teardrop compression seal
- / equipped with a durable self-adhesive backing tape
- / suitable for sound insulation and smoke sealing
- / ensures soft closing of the door
- / also suitable for retro-fit applications

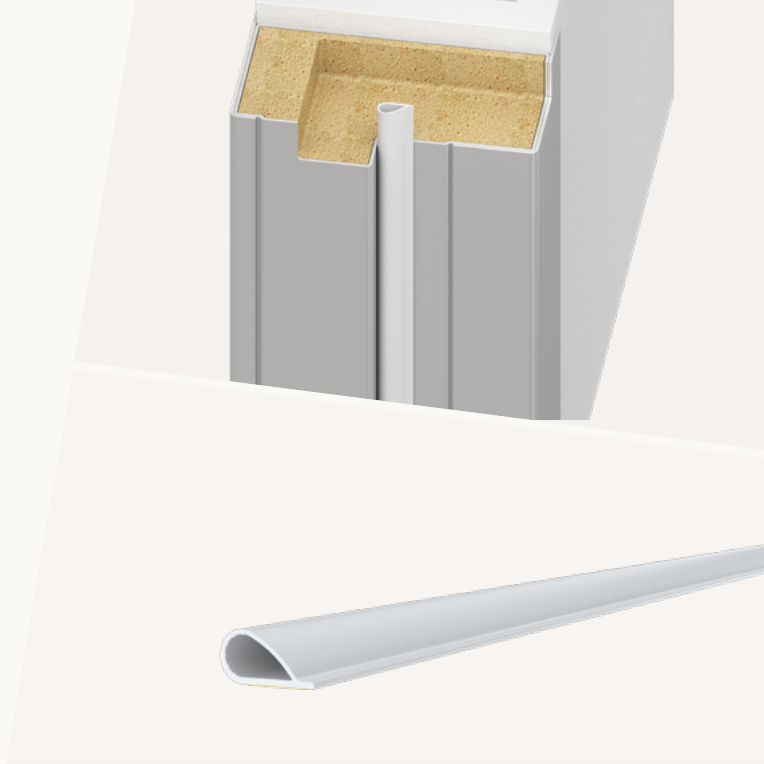

## TECHNICAL DATA

Application	timber & metal door frames
Gasket material	silicone, self-extinguishing
Working temperature range	-20°C to +80°C

## DIMENSIONS

Width x height	12.8 x 6.4 mm
Fitting tolerance range	2 - 5.5 mm
Standard lengths	50m coil

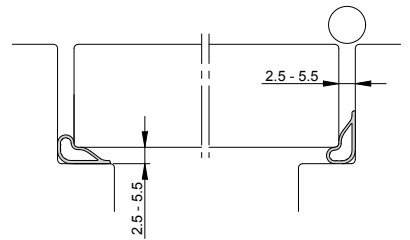
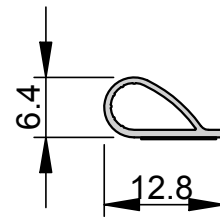

## FIXING

Fixing	stuck to the door stop with self-adhesive backing tape
--------	--

## PERFORMANCE & CERTIFICATES

Fire	EN1634-1**
UL	UL10C (R38166)

## COLORS

## ART.NO.

Black	P160040
Grey	P160078
White	P160042
Brown	P160041
Dark brown	P160041
Brown	P160216
Cream	P160217

\*\*The test value may differ according to the EN 1634-1 test, as the complete door system must be checked.

# PS 1108 S

- / single fin seal
- / equipped with a durable self-adhesive backing tape
- / suitable for sound insulation and for smoke sealing
- / well suited to tighter gaps and as a second frame seal
- / also suitable for retro-fit applications

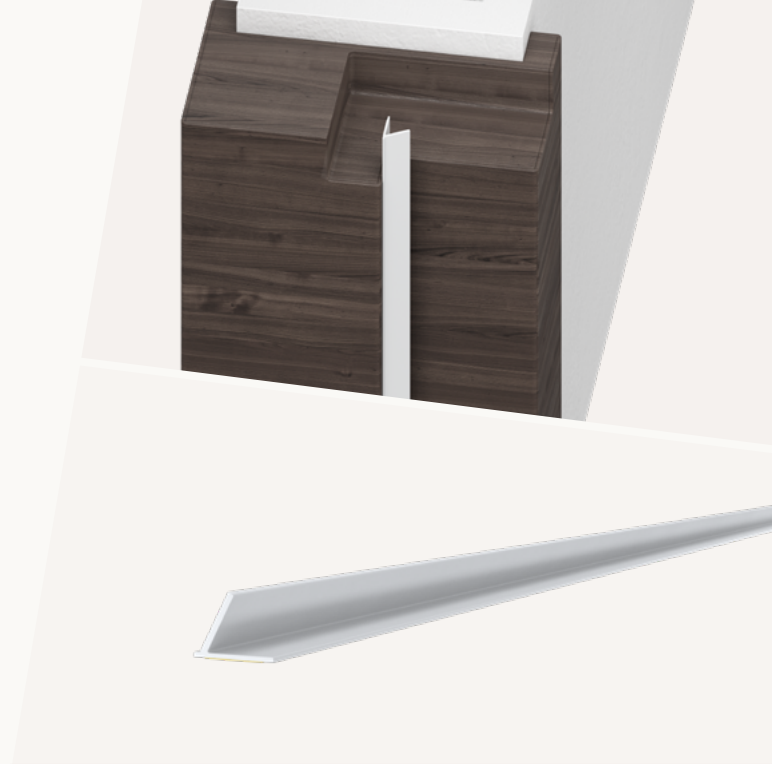

## TECHNICAL DATA

Application	timber & metal door frames
Gasket material	silicone, self-extinguishing
Working temperature range	-20°C to +80°C

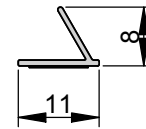

## DIMENSIONS

Width x height	11 x 8 mm
Fitting tolerance range	2.5 -7 mm
Standard lengths	6 m, 50 m coil

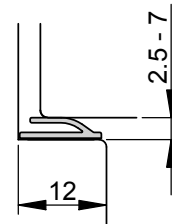

## FIXING

Fixing	stuck to the door stop with self-adhesive backing tape
--------	--

## COLORS

COLORS	ART.NO.
Black	P160227
Brown	P160226
White	P160228
Grey	P160229
Dark brown	P160225
Cream	P160230



**PS 1010 P**  
**PS 1212 P**  
**PS 1515 P**

- / winged corner seal
- / equipped with two rows of durable self-adhesive backing tape
- / suitable for sound insulation and for smoke sealing
- / ensures soft closing of the door
- / also suitable for retro-fit applications

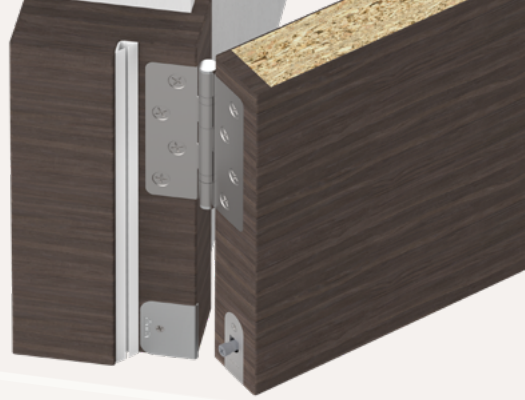

**TECHNICAL DATA**

Application	timber & metal door frames
Gasket material	rigid PVC base, flexible PVC fins
Working temperature range	-15°C to +60°C

**DIMENSIONS**

Standard lengths	2100, 2400, 3000 mm
------------------	---------------------

**FIXING**

Fixing	stuck to the door stop with self-adhesive backing tape
--------	--

**PERFORMANCE & CERTIFICATES**

UL	UL 10C (R38166)
Fire	EN1634-1*

<b>COLORS/ART.NO.</b>	<b>PS 1010 P</b>	<b>PS 1212 P</b>	<b>PS 1515 P</b>
Black	P160043	P160046	P160049
Dark brown	P160044	P160047	P160050
White	P160045	P160048	P160051

\*The test value may differ according to the EN 1634-1 test, as the complete door system must be checked.





	PS 1010 P	PS 1212 P	PS 1515 P
Fitting tolerance range	3 - 4 mm	3 - 4 mm	3 - 4 mm
Width x height	10 x 10 mm	12 x 12 mm	15 x 15 mm

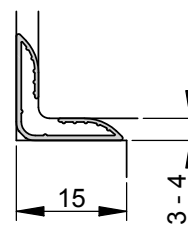
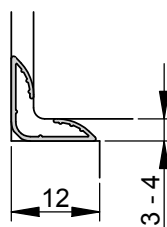
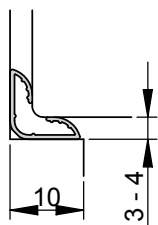
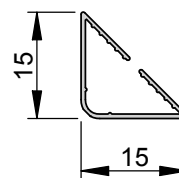
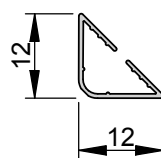
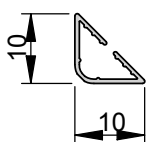



**PS 1010 P Flex**  
**PS 1212 P Flex**  
**PS 1515 P Flex**

- / winged corner seal with flexible base
- / equipped with two rows of durable self-adhesive backing tape
- / flexible base offers more flexibility during installation
- / ensures soft closing of the door
- / also suitable for retro-fit applications

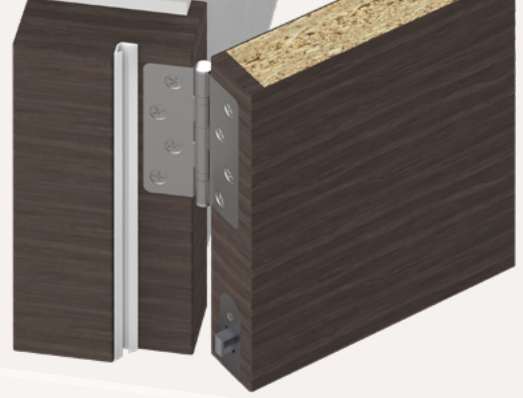

**TECHNICAL DATA**

Application	timber and metal door frames
Gasket material	rigid and flexible PVC co-extrusion
Working temperature range	-15°C to +60°C

**DIMENSIONS**

Standard lengths	2100, 2200, 2400, 2500, 3000 mm
------------------	---------------------------------

**FIXING**

Fixing	stuck to the door stop with self-adhesive backing tape
--------	--

**PERFORMANCE & CERTIFICATES**

UL	UL 10C (R38166)
----	-----------------

<b>COLORS/ART.NO.</b>	<b>PS 1010 P Flex</b>	<b>PS 1212 P Flex</b>	<b>PS 1515 P Flex</b>
Black	P160130	P160136	P160138
Dark brown	P160132	P160137	P160139
Brown	P160211	P160209	P160210
White	P160131	P160135	P160140
Grey	P160159	P160147	P160151
Cream	P160160	P160146	P160161



	PS 1010 P Flex	PS 1212 P Flex	PS 1515 P Flex
Fitting tolerance range	2 - 4 mm	2 - 4 mm	2 - 4 mm
Width x height	10 x 10 mm	12 x 12 mm	15 x 15 mm

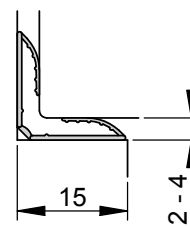
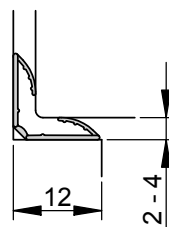
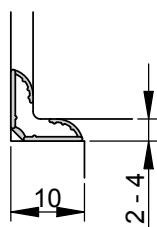
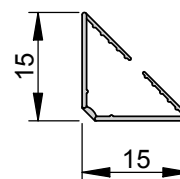
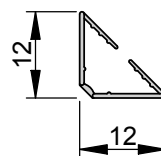
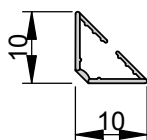



# PS 744 S

- / single fin seal
- / equipped with a durable self-adhesive backing tape
- / suitable for sound insulation and for smoke sealing
- / well suited to tighter gaps and as a second frame seal
- / also suitable for retro-fit applications

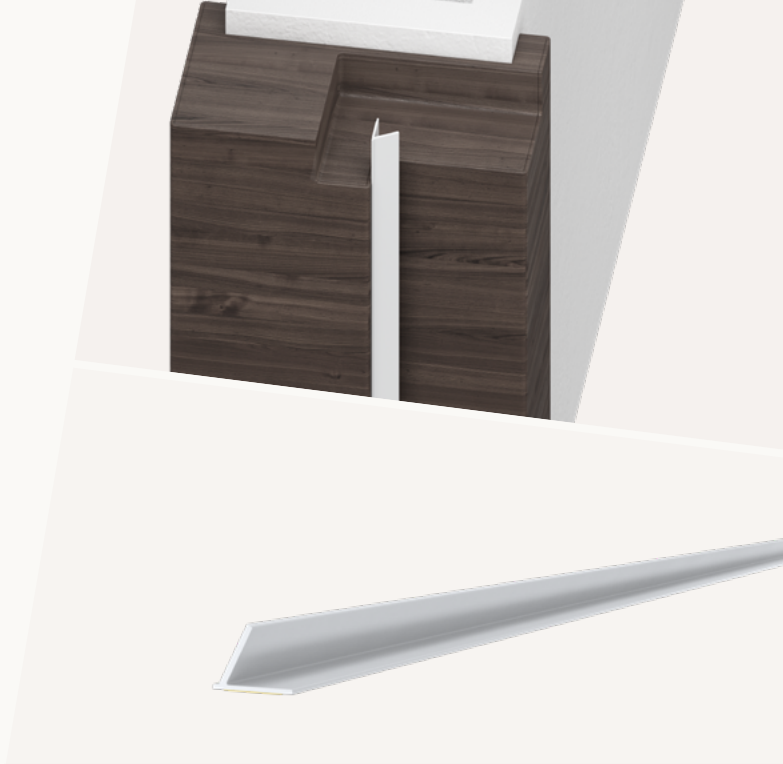

## TECHNICAL DATA

Application	timber & metal door frames
Gasket material	silicone, self-extinguishing
Working temperature range	-20°C to +80°C

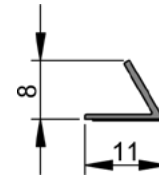

## DIMENSIONS

Width x height	11 x 8 mm
Fitting tolerance range	3 -7 mm
Standard lengths	62m coil, 155m coil

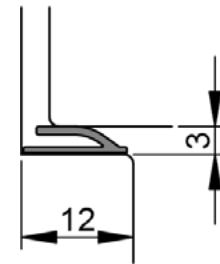

## FIXING

Fixing	stuck to the door stop with self-adhesive backing tape
--------	--

## PERFORMANCE & CERTIFICATES

UL	UL 10C (R38166)
----	-----------------

## COLORS

## ART.NO.

black	P160104
Brown	P160102
White	P160105
Light grey	P160103





# PS 1310 S

- / triple fin seal
- / equipped with a durable self-adhesive backing tape
- / suitable for sound insulation
- / suitable for smoke protection
- / also suitable for retro-fit applications

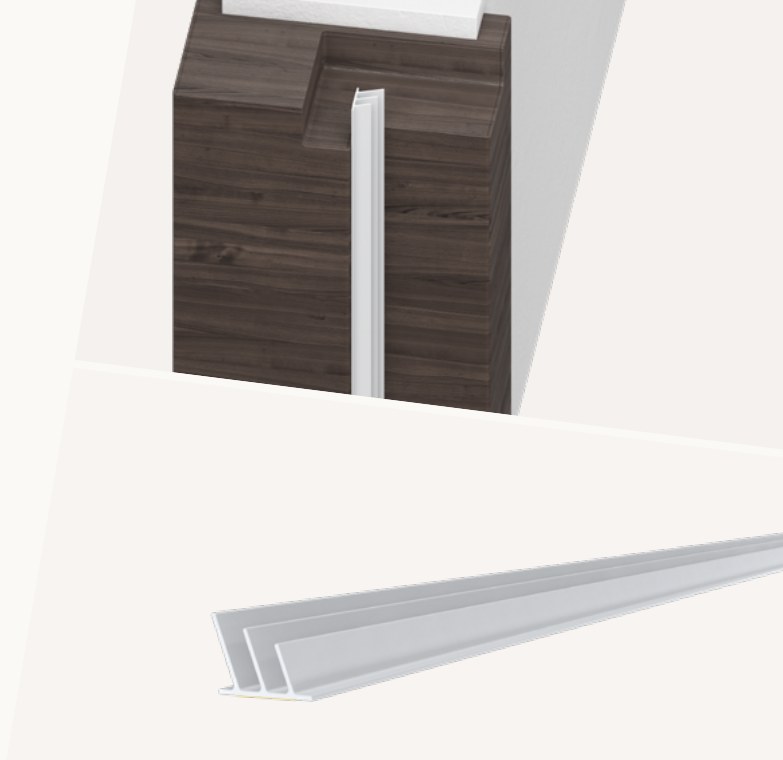

## TECHNICAL DATA

Application	timber & metal door frames
Gasket material	silicone, self-extinguishing
Working temperature range	-20°C to +80°C

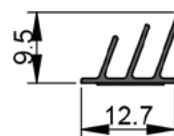

## DIMENSIONS

Width x height	12.7 x 9.5 mm
Fitting tolerance range	2 -7 mm
Standard lengths	62m coil, 155m coil

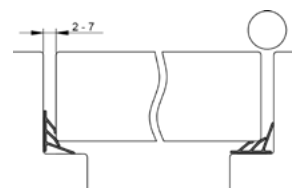

## FIXING

Fixing	stuck to the door stop with self-adhesive backing tape
--------	--

## PERFORMANCE & CERTIFICATES

UL	UL 10C (R38166)
----	-----------------

## COLORS

## ART.NO.

Black	P160113
Brown	P160111
White	P160114
Light grey	P160112

## PS 810 TE

- / stop-mounted compression seal
- / equipped with a durable self-adhesive backing tape
- / suitable for sound insulation and for smoke sealing
- / ensures soft closing of the door
- / also suitable for retro-fit applications

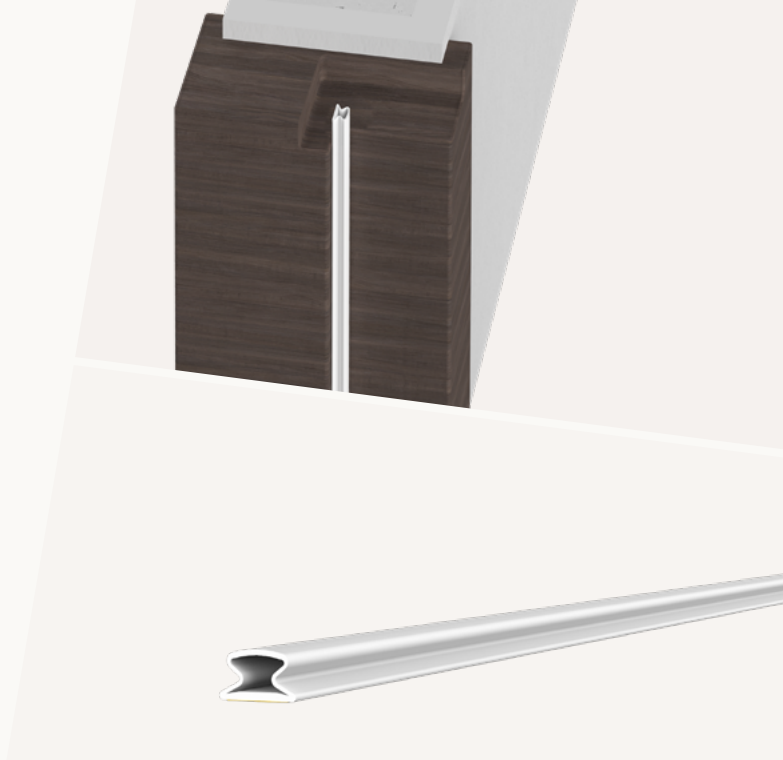

### TECHNICAL DATA

Application	timber frames
Gasket material	TPE
Working temperature range	-20°C to +80°C

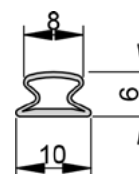

### DIMENSIONS

Width x height	10 x 6 mm
Fitting tolerance range	3.5 - 5 mm
Standard lengths	200m coil

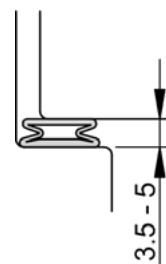

### FIXING

Fixing	stuck to the door stop with self-adhesive backing tape
--------	--

### COLORS

COLORS	ART.NO.
Black	P160061
Brown	P160066
White	P160059
Grey	P160060

## PS 812 TE

- / stop-mounted compression seal
- / equipped with a durable self-adhesive backing tape
- / suitable for sound insulation and for smoke sealing
- / ensures soft closing of the door
- / also suitable for retro-fit applications

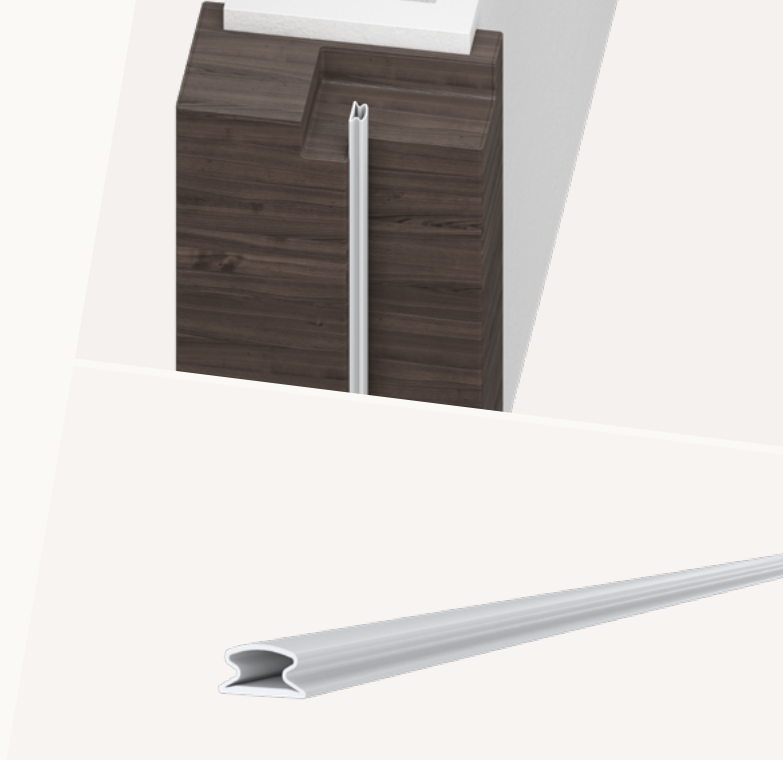

### TECHNICAL DATA

Application	timber frames
Gasket material	TPE
Working temperature range	-20°C to +80°C

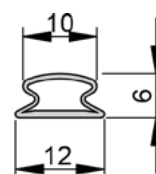

### DIMENSIONS

Width x height	12 x 6 mm
Fitting tolerance range	3.5 - 5 mm
Standard lengths	100m coil

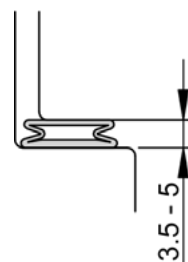

### FIXING

Fixing	stuck to the door stop with self-adhesive backing tape
--------	--

### COLORS

COLORS	ART.NO.
Black	P160064
Brown	P160063
White	P160062

### **UPGRADE EXISTING DOORS**

- / Improves the sound insulation and smoke control of existing doors

### **EASE OF INSTALLATION**

- / Install on existing doors without the need to dismantle the complete door system



# **NADI<sup>®</sup>**

## **RETROFIT SEALING SOLUTION**



### **SLIMLINE, DISCREET & STYLISH**

- / Slimline design and pre-finished features enable maximum architectural freedom and simple installation

### **FUTURE-PROOF & MAINTENANCE-FREE**

- / Uneven gaps caused by door warping can be overcome automatically, ensuring future technical performance

### **NATURALLY CERTIFIED**

- / Reference smoke testing in accordance with EN 1634-3 showcases suitability as a smoke seal for existing fire doors

### **BUDGET CERTAINTY**

- / Nadi® is priced & supplied per set, rather than per linear metre, offering maximum budget certainty



## Nadi® LM

## Nadi® FM

- / retrofit perimeter and meeting stile seal for reveal mounting
- / spring mechanism automatically adjusts up to 10mm to offset door warping (optionally 14mm)
- / Elongated holes, snap-on cover plate and pre-formed corners for easy installation
- / sets available for both single and double doors

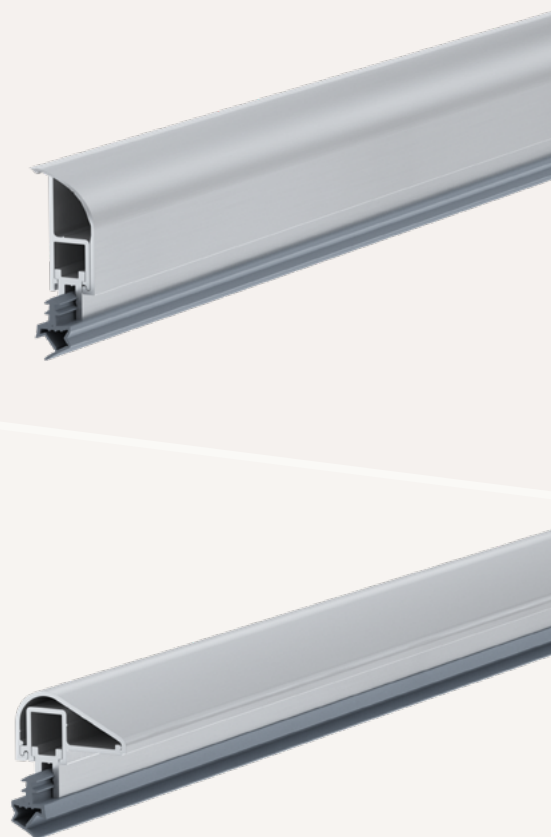

### DIMENSIONS

#### Nadi® LM

#### Nadi® FM

Tolerance compensation 10 mm (optionally 14 mm)

Width & height, actuated 10,3 & 29 mm

25,4 & 18 mm

### TECHNICAL DATA

#### Nadi® LM

#### Nadi® FM

Application hinged timber & metal doors

Material self-extinguishing, flame retardant silicone

Fixing mounted to the frame on closing face, screw fixed

mounted to the frame reveal on closing face, screw fixed

Performance Smoke: EN 1634-3

Can be shortened 150 mm

## SET COMPONENTS

/ Nadi® LM

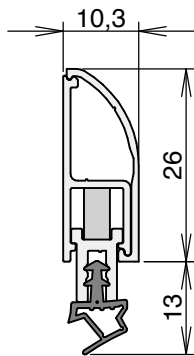

/ Nadi® FM

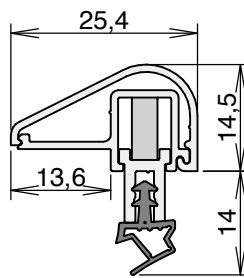

### LENGTHS/ART.NO.

	Nadi® LM set	Nadi® FM set	
Single-leaf door (mm)	H 2,100 x W 650 - 950	320 200	320 235
	H 2,100 x W 951 - 1,250	320 201	320 236
	H 2,100 x W 1,251 - 1,500	320 202	320 237
	H 2,400 x W 650 - 950	320 208	320 238
	H 2,400 x W 951 - 1,250	320 209	320 239
	H 2,400 x W 1,251 - 1,500	320 210	320 240
	H 2,700 x W 650 - 950	320 216	320 241
	H 2,700 x W 951 - 1,250	320 217	320 242
	H 2,700 x W 1,251 - 1,500	320 218	320 243
	H 3,000 x W 650 - 950	320 225	320 244
	H 3,000 x W 951 - 1,250	320 226	320 245
	H 3,000 x W 1,251 - 1,500	320 227	320 246
	Double-leaf door (mm)	H 2,100 x W 951-1,250	320 203
H 2,100 x W 1,251 - 1,500		320 204	320 248
H 2,100 x W 1,501 - 1,800		320 205	320 249
H 2,100 x W 1,801 - 2,100		320 206	320 250
H 2,100 x W 2,101 - 2,400		320 207	320 251
H 2,100 x W 2,401 - 2,700		320 316	-
H 2,400 x W 951 - 1,250		320 211	320 252
H 2,400 x W 1,251 - 1,500		320 212	320 253
H 2,400 x W 1,501 - 1,800		320 213	320 254
H 2,400 x W 1,801 - 2,100		320 214	320 255
H 2,400 x W 2,101 - 2,400		320 215	320 256
H 2,400 x W 2,401 - 2,700		320 317	-
H 2,700 x W 951 - 1,250		320 219	320 257
H 2,700 x W 1,251 - 1,500		320 220	320 258
H 2,700 x W 1,501 - 1,800		320 221	320 259
H 2,700 x W 1,801 - 2,100		320 222	320 260
H 2,700 x W 2,101 - 2,400		320 223	320 261
H 2,700 x W 2,401 - 2,700		320 224	320 262
H 3,000 x W 951 - 1,250		320 228	320 263
H 3,000 x W 1,251 - 1,500		320 229	320 264
H 3,000 x W 1,501 - 1,800	320 230	320 265	
H 3,000 x W 1,801 - 2,100	320 231	320 266	
H 3,000 x W 2,101 - 2,400	320 232	320 267	
H 3,000 x W 2,401 - 2,700	320 233	320 268	
H 3,000 x W 2,701 - 3,000	320 234	320 269	

Further sets on request.

1 Perimeter seals  
1.3 surface mounted perimeter seals

athmer.com



# PS 2807 S

- / surface-mounted acoustic perimeter seal for fitting around the head and jambs of existing doors
- / slim design
- / with elongated fixing holes for easy positioning and adjustment
- / fixing screws concealed by snap on cover
- / also suitable for retro-fit applications

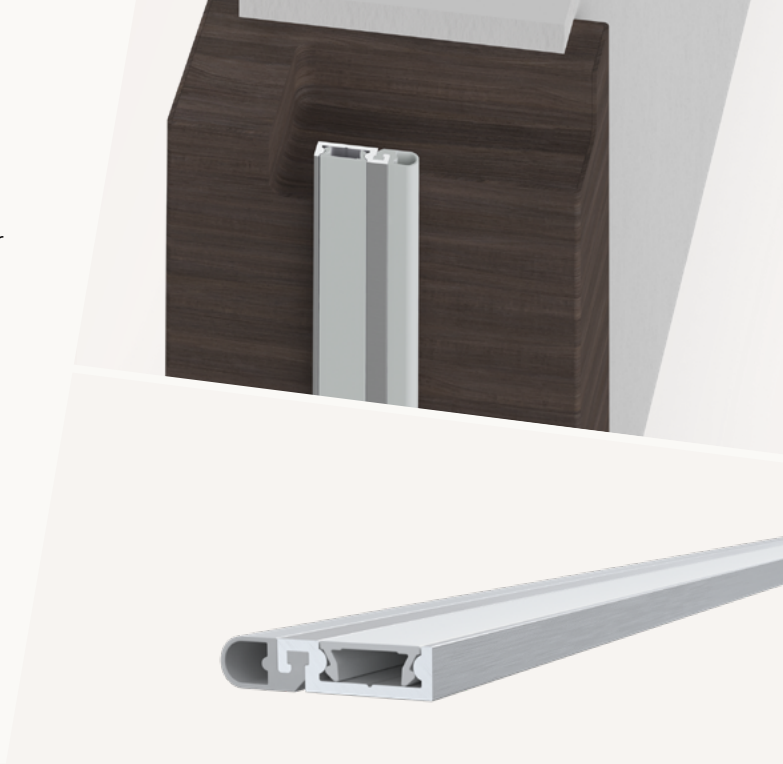

## TECHNICAL DATA

Application	timber & metal frames
Gasket material	silicone self-extinguishing
Carrier material	aluminum, anodized
Working temperature range	-40°C to +200°C

## DIMENSIONS

Width x height	28 x 6 mm
Fitting tolerance range	2 - 6 mm
Standard lengths	1.000, 2.100, 2.250, 2.500, 3.000 mm
Max. lengths	3.000 mm
Can be shortened by	any lengths

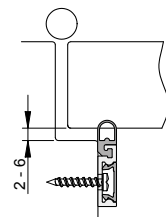
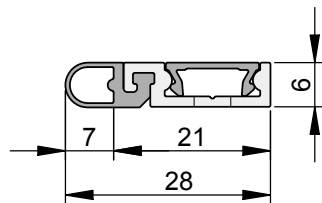

## FIXING

Fixing	surface mounted to the door frame, screw fixed
--------	--

## PERFORMANCE & CERTIFICATES

UL	UL 10C (R38166)
----	-----------------

COLORS (carrier, gasket)	ART.NO.	ACCESSORIES (incl. in delivery)
Silver anodized, grey	8-111	S019
Black anodized, black	8-112	S019



## PS 3607 S

- / surface-mounted acoustic perimeter seal for fitting around the head and jambs of existing doors
- / slim design
- / with elongated fixing holes for easy positioning and adjustment
- / fixing screws concealed by a snap on cover profile made of anodized aluminum
- / also suitable for retro-fit applications

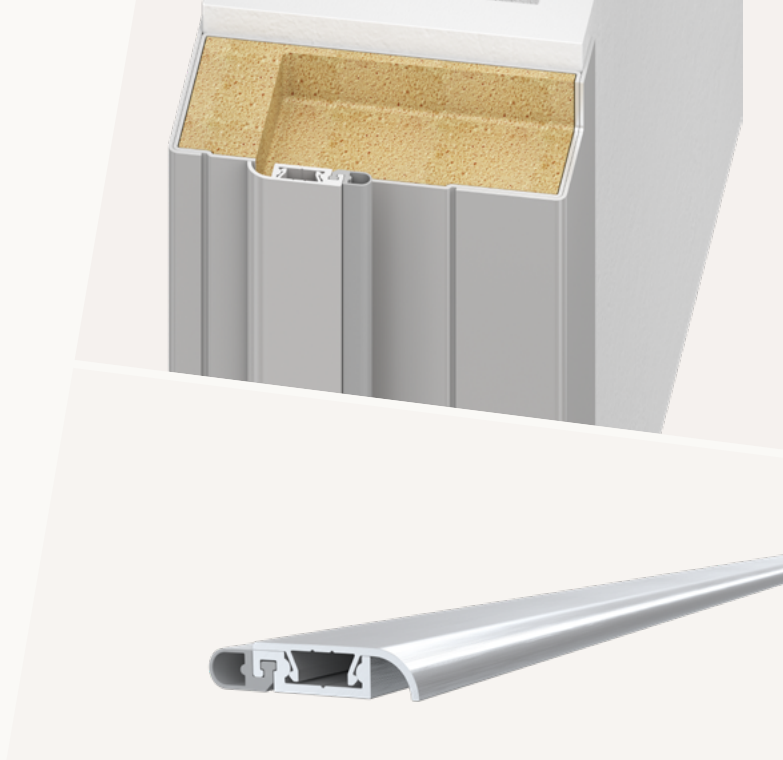

### TECHNICAL DATA

Application	timber & metal frames
Gasket material	silicone, self-extinguishing
Carrier material	aluminum, anodized
Working temperature range	-40°C to +200°C

### DIMENSIONS

Width x height	36 x 7 mm
Fitting tolerance range	2 - 6 mm
Standard lengths	1.000, 2.100, 2.250, 2.500, 3.000 mm
Maximum lengths	3.000 mm
Can be shortened by	any length

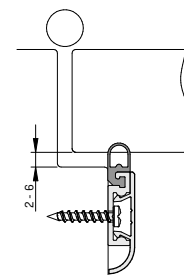
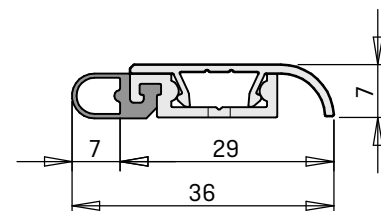

### FIXING

Fixing	surface mounted to the door frame, screw fixed
--------	--

### PERFORMANCE & CERTIFICATES

UL	UL 10C (R38166)
----	-----------------

COLORS (carrier, gasket)	ART.NO.	ACCESSORIES (incl. in delivery)
Silver anodized, grey	8-113	S019
Black anodized, black	8-114	S019





# PS 2816 S

- / surface-mounted acoustic perimeter seal for fitting around the head and jambs of existing doors
- / with elongated fixing holes for easy positioning and adjustment
- / fixing screws concealed by snap on cover
- / also suitable for retro-fit applications

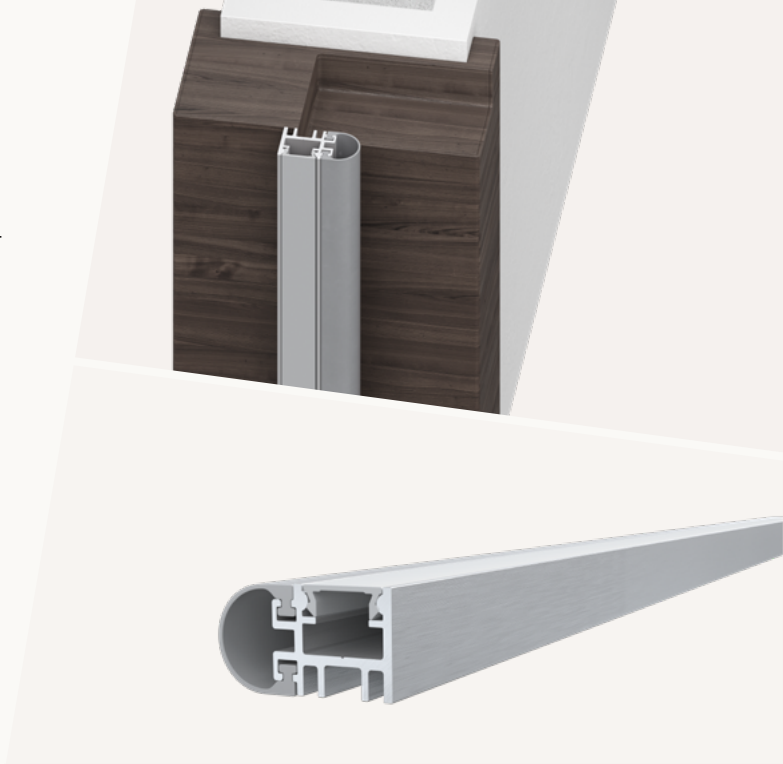

## TECHNICAL DATA

Application	timber & metal frames
Gasket material	silicone, self-extinguishing
Carrier material	aluminum, anodized
Working temperature range	-40°C to +200°C

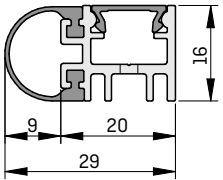

## DIMENSIONS

Width x height	29 x 16 mm
Fitting tolerance range	3 - 8 mm
Standard lengths	1.000, 2.100, 2.250, 2.500, 3.000 mm
Maximum lengths	3.000 mm
Can be shortened by	any length

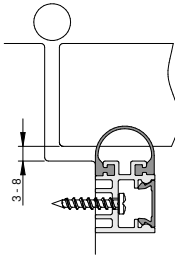

## FIXING

Fixing	surface mounted to the door frame, screw fixed
--------	--

## PERFORMANCE & CERTIFICATES

UL	UL 10C (R38166)
----	-----------------

COLORS (carrier, gasket)	ART.NO.	ACCESSORIES (incl. in delivery)
Silver anodized, grey	8-115	S023
Black anodized, black	8-116	S023

## Unitherm FAS-20

- / aluminium stop-mounted perimeter seal
- / anodised aluminium carrier
- / suitable for sound insulation
- / suitable for smoke protection

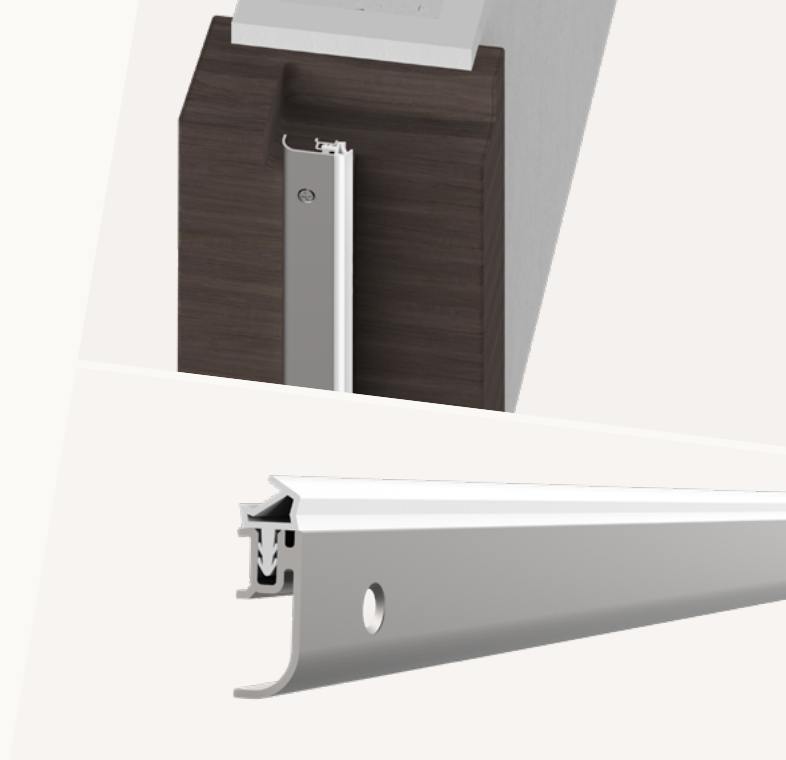

### TECHNICAL DATA

Application	timber and metal frames
Gasket material	TPE
Carrier material	aluminum

### DIMENSIONS

Width x height	8,5 x 26 mm
Standard lengths	2100 mm
Can be shortened by	any length

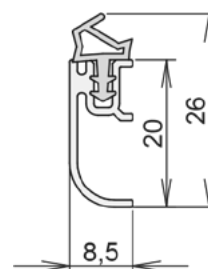

### FIXING

Fixing	surface mounted to the door frame, screw fixed
--------	--

<b>COLORS</b> [carrier, gasket]	<b>ART.NO.</b>
Silver anodized, grey	319204



# AS 2519 S

- / astragal/meeting stile seal
- / wide compression range
- / extremely low compression force for feather-light operation
- / also suitable for retro-fit applications

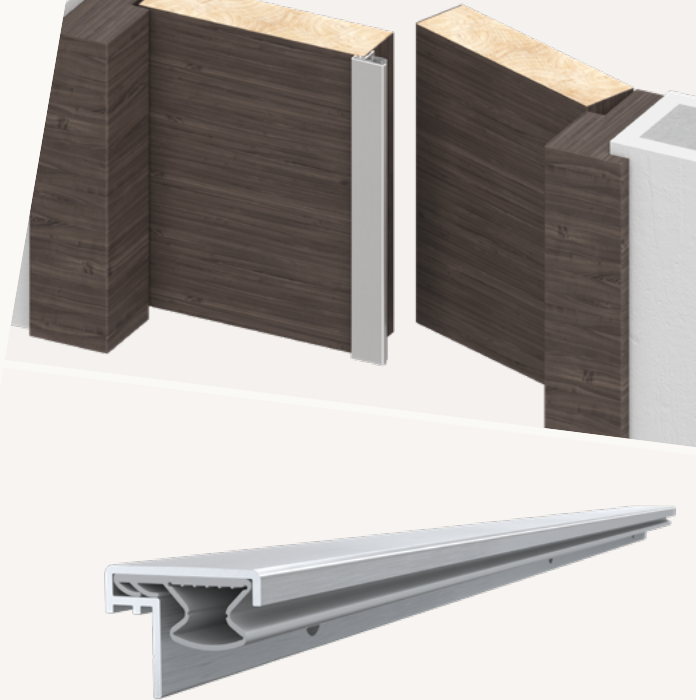

## TECHNICAL DATA

Application	double-leaf timber and metal doors
Gasket material	silicone self-extinguishing
Carrier material	aluminum, anodized
Working temperature range	-40°C to +200°C

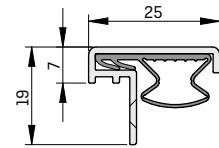

## DIMENSIONS

Width x height	25 x 19 mm
Fitting tolerance range	0 - 4.5 mm
Standard lengths	2.100, 2.250, 2.500, 3.000 mm
Max. lengths	3.000 mm
Can be shortened by	any lengths

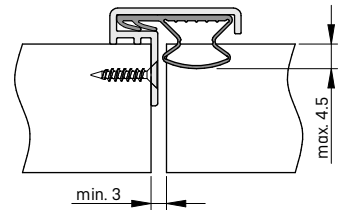

## FIXING

Fixing	screw fixed to the meeting stile of double wing doors
--------	---

## PERFORMANCE & CERTIFICATES

UL	UL 10C (R38166)
----	-----------------

COLORS (carrier, gasket)	ART.NO.	ACCESSORIES (incl. in delivery)
Silver anodized, grey	8-101	S020



# PS 2806 S

- / surface-mounted acoustic perimeter seal for fitting around the head and jambs of existing doors
- / slim design
- / triple fin gasket
- / with elongated fixing holes for easy positioning and adjustment
- / fixing screws concealed by snap on cover

## TECHNICAL DATA

Application	timber & metal frames
Gasket material	silicone self-extinguishing
Carrier material	aluminum, anodized
Working temperature range	-40°C to +200°C

## DIMENSIONS

Width x height	28 x 6 mm
Fitting tolerance range	3 - 6 mm
Standard lengths	1.000, 2.100, 2.250, 2.500, 3.000 mm
Max. lengths	3.000 mm
Can be shortened by	any lengths

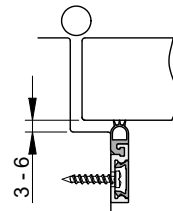
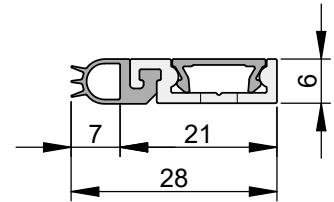

## FIXING

Fixing	surface mounted to the door frame, screw fixed
--------	--

## PERFORMANCE & CERTIFICATES

UL	UL 10C [R38166]
----	-----------------

COLORS [carrier, gasket]	ART.NO.	ACCESSORIES [incl. in delivery]
Silver anodized, grey	8-119	S019

## Pivot L-15 (set)

- / complete four-sided pivot hinge door solution
- / suitable with single- and double-acting doors
- / ground-breaking roller actuator suitable for various frame designs
- / set includes additional frame actuation roller for fitting to scalloped frames
- / supplied with magnetic seals for the vertical edges of door



<b>DIMENSIONS</b>	<b>Schall-Ex® L-15/30 Pivot</b>	<b>Slide magnet</b>
Travel	12 mm	
Gap size		6 mm

<b>TECHNICAL DATA</b>	<b>Schall-Ex® L-15/30 Pivot</b>	<b>Slide magnet</b>
Actuation	single	-
Material	self-extinguishing, flame retardant silicone	aluminium, silicone
Fixing	surface-mounted top and bottom	two part system surface-mounted to frame and door
Standard lengths	833, 958, 1,083, 1,208 mm (can be shortened 125 mm)	2,500 / 3,000 mm
Min/max lengths	235 mm / 2,000 mm	- / 3,000 mm
Accessories	5817	-



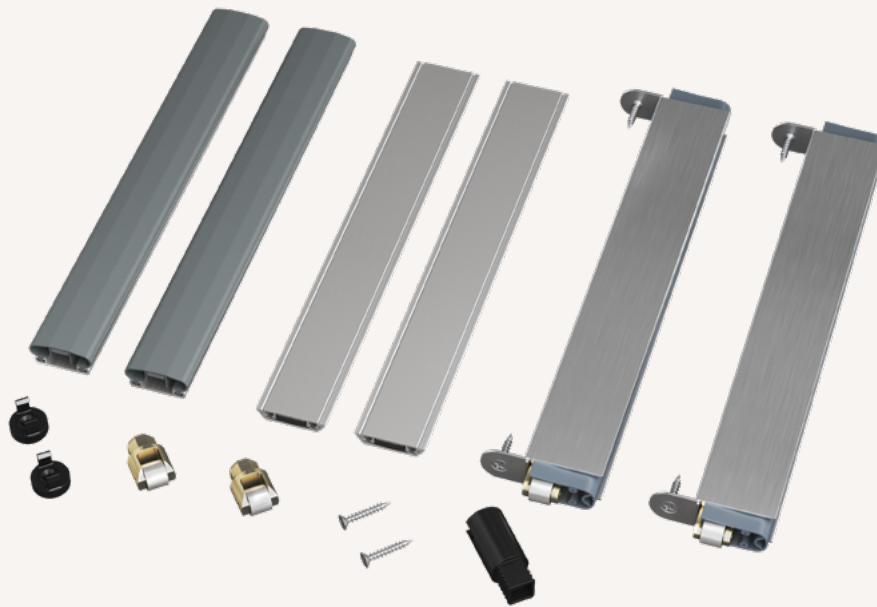

### SET COMPONENTS

/ Schall-Ex® L-15/30 WS Pivot (incl. roller actuator for frame)[2 pcs.]

/ Slide magnet [2 pc.]

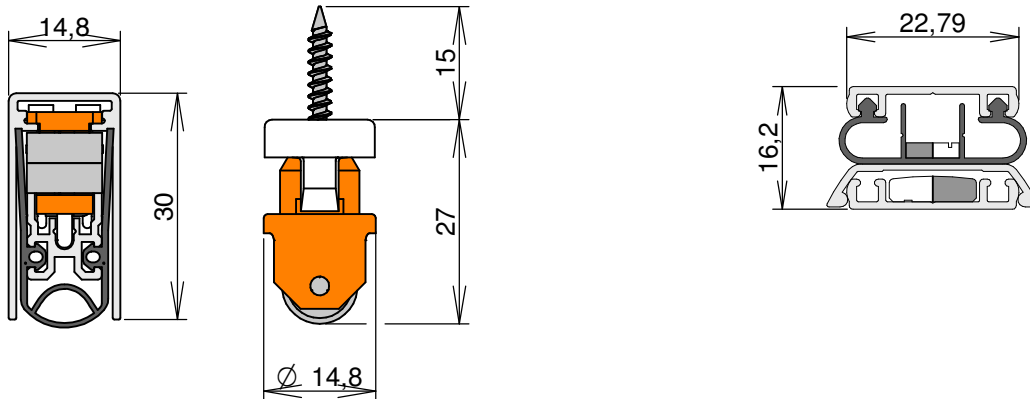

COLOURS/ART.NO.	Lengths slide magnet	
	2,500 mm	3,000 mm
Silver-colored, anod. (C-0)	1-1027	1-1028
Stainless steel-colored (C-31)	1-1029	1-1030

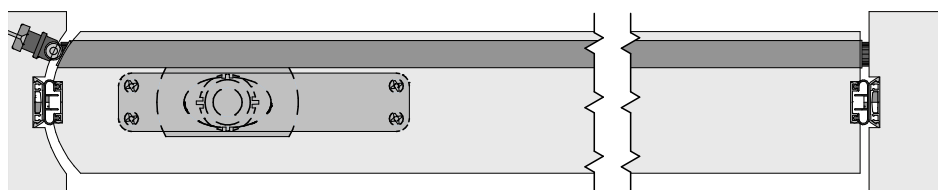

**1 Perimeter seals**  
1.4 perimeter seals for sliding and pivot doors

athmer.com

## Universal M-12 (set)

- / complete four-sided sliding door solution
- / can be fitted to timber, glass and metal doors
- / supplied with magnetic seals for the vertical edges of door
- / self-locking system - no additional latching or locking required



DIMENSIONS	Schall-Ex® Slide M-12 WS ZU	Slide magnet	Niroschwelle 365
Travel	11 mm		
Height x width	13,7 x 48,5 mm	28 x 29 mm	40 x 2,5 mm

TECHNICAL DATA	Schall-Ex® Slide M-12 WS ZU	Slide magnet	Niroschwelle 365
Actuation	single	-	-
Material	self-extinguishing, flame retardant silicone	aluminium, silicone	stainless steel
Fixing	surface-mounted top and bottom	two part system surface-mounted to frame and door	
Standard lengths	Fixed lengths only (cannot be shortened)	2,500 / 3,000 mm	Fixed lengths only
Min/max lengths	450 mm / 1,500 mm	- / 3,000 mm	- / 1,500 mm
Accessories	5144	-	-

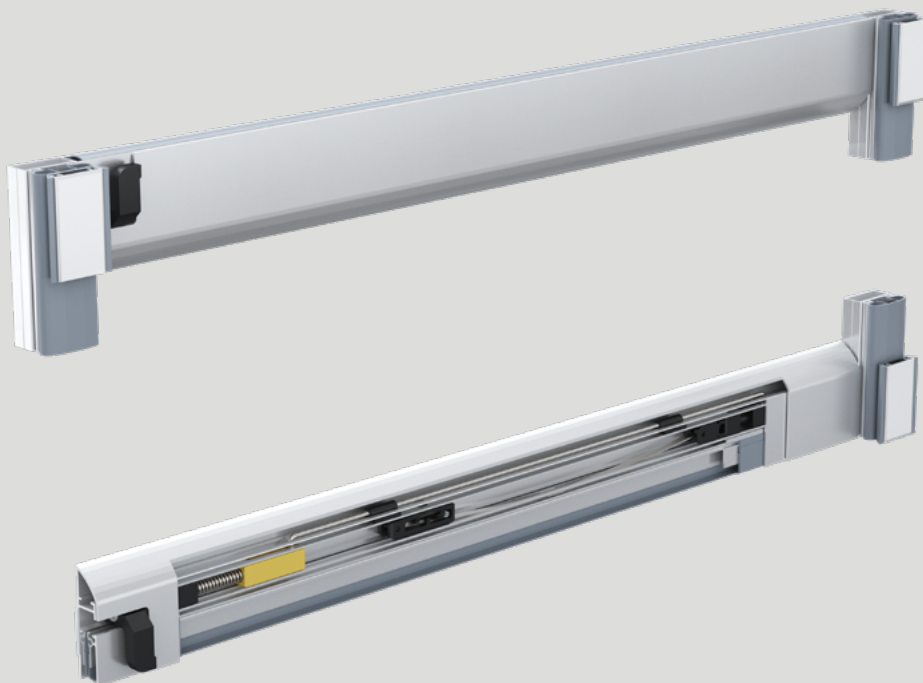

## SET COMPONENTS

/ Schall-Ex® Slide M-12 WS ZU [2 pcs.]

/ Slide magnet [2 pcs.]

/ Niroschwelle 365 [1 pc.]

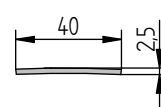
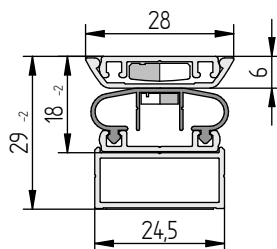
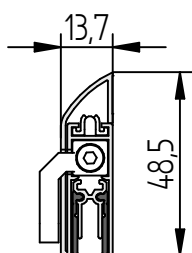

## COLOURS/ART.NO.

### Lengths slide magnet

2,500 mm

3,000 mm

Silver-colored, anod. (C-0)

1-1015

1-1016

Stainless steel-colored (C-31)

1-1013

1-1014

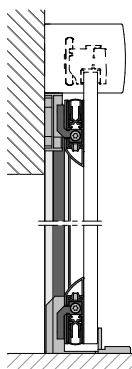

Glass door

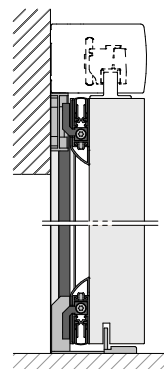
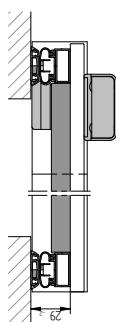

Timber door

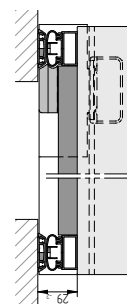

1 Perimeter seals  
1.4 perimeter seals for sliding and pivot doors

athmer.com

## VHH M-12 (set)

- / top and bottom drop seal set for sliding doors
- / additional adaptor supplied for top of door
- / can be fitted to pocket & wall-mounted doors
- / can be fitted to most roller systems utilising an M8 bolt connection
- / magnet supplied for use with unlatched doors
- / combine with ZD Slide 12/12 vertical seal (optional)



### DIMENSIONS

Groove width	12 mm
Travel	11 mm

### TECHNICAL DATA

#### Schall-Ex® Slide M-12 SLA

Application	sliding timber doors
Actuation	single
Material	self-extinguishing, flame retardant silicone
Fixing	Bottom: rebated into a groove in the door, screw fixed both sides Top: screw fixed with an adaptor
Standard lengths	708, 833, 958, 1,083, 1,208 mm (can be shortened: 125 mm)
Min/max lengths	280 mm / 1,958 mm
Accessories	5106
Art.No.	1-839

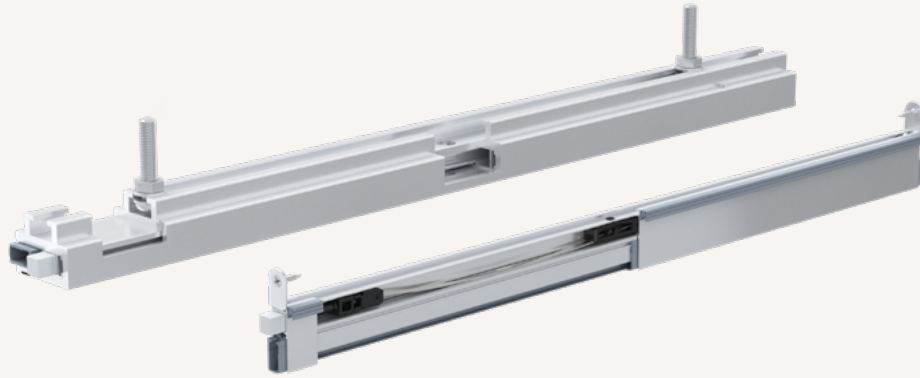

### SET COMPONENTS

/ Schall-Ex® Slide M-12 SLA [2 pcs.]

/ Slide adapter 12 [1 pc.]

/ M8 bolt and fixings [2 pcs.]

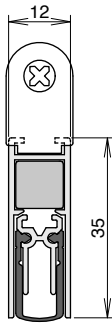

/ door guide [1 pc.]

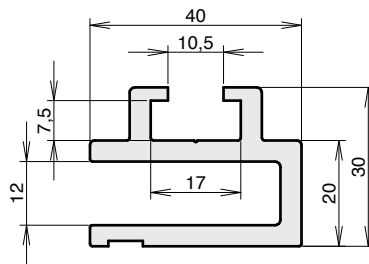

/ magnet [2 pcs.]



/ slide spacer [1 pc.]

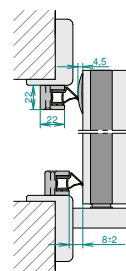
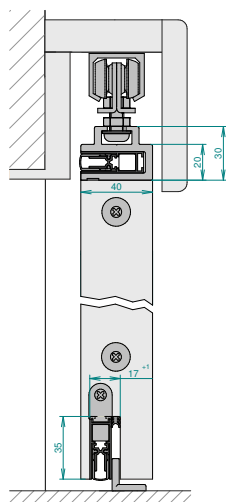

**1 Perimeter seals**  
1.4 perimeter seals for sliding and pivot doors

athmer.com



## ZD Slide 12/12

- / rebated sliding door perimeter seal
- / suitable for sound insulation
- / suitable for smoke sealing

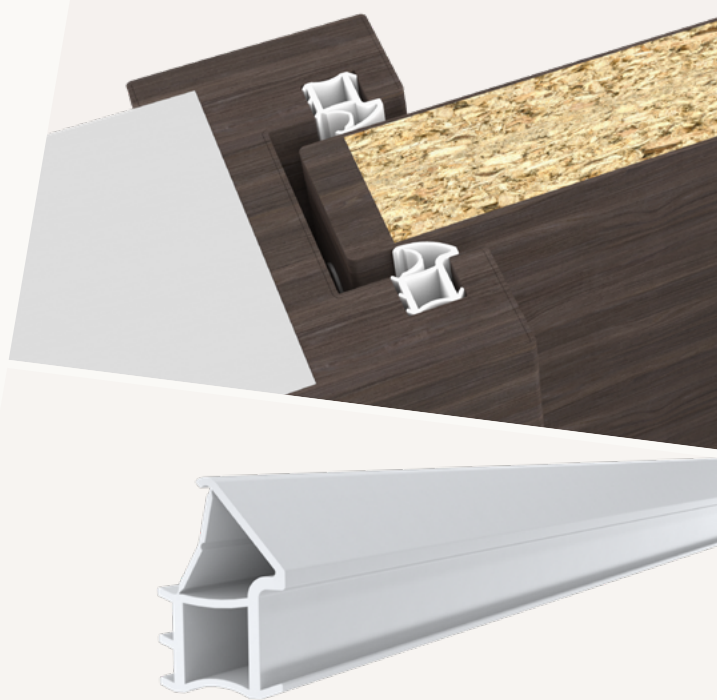

### TECHNICAL DATA

Application	timber and metal frame rebates
Gasket material	silicone

### DIMENSIONS

Width x height	16.5 x 25 mm
Fitting tolerance range	6 - 10 mm
Standard lengths	per meter

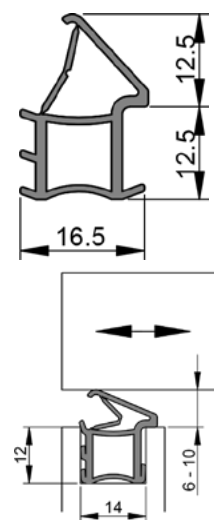

### FIXING

Fixing	into a groove in the sliding door frame
--------	---

### COLORS

Grey

### ART.NO.

210

## Slide VN 8/10

- / glass door-mounted perimeter seal
- / suitable for sound insulation
- / suitable for smoke sealing

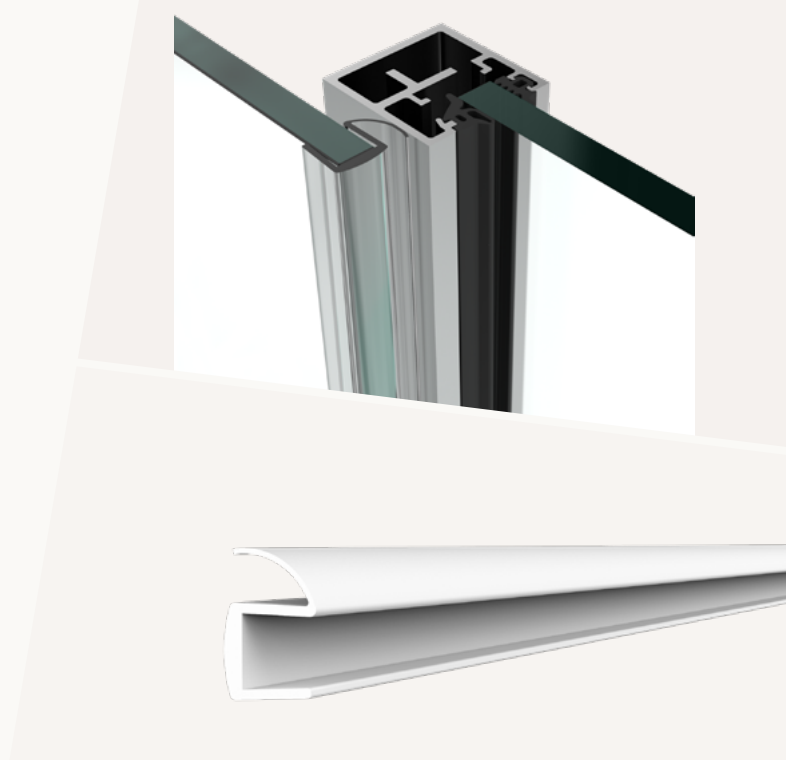

### TECHNICAL DATA

Application	frameless sliding glass doors
Gasket material	silicone

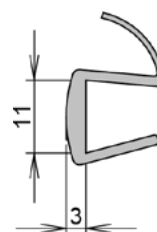

### DIMENSIONS

Fitting tolerance range	6 - 10 mm
Standard lengths	per metre

### FIXING

Fixing	slip onto the edge of the glass door
--------	--------------------------------------

### COLORS

Transparent

### ART.NO.

523

Rebated drop seals  
for hinged doors

# Classic solutions for everyday doors

Our range of rebated drop seals for timber doors is already well-established in the industry following **decades of assured quality** and consistent innovation. This type of drop seal is fitted into a grooved rebate in the bottom of timber doors, remaining hidden during daily use. As a result, door designers can meet performance requirements whilst maintaining the door's aesthetic quality regardless of the chosen material, style and finish.

The seal drops automatically when the door is closed to form a seal with the floor, retracting when the door is opened to ensure the door operation is unhindered. This section contains options for use with both hinged and pivoted timber doors. Their main purpose is to provide an **effective barrier against sound** transfer at the door threshold, as well as smoke, air, light, dirt, dust, insects and odours. We have tested options for specialist applications including protection from radiation, corrosion and weather elements such as wind and driving rain.



**Rebated drop seals**  
for hinged doors



# Schall-Ex® L-8/30 WS

## 1-1000

- / for the 2nd sealing level of highly sound-insulating doors
- / parallel lowering
- / no offset of the inner profile
- / slide-out inner profile
- / level compensation for uneven floors



### TECHNICAL DATA

Application	hinged timber doors
Actuation	single
Gasket material	self-extinguishing silicone

### DIMENSIONS

Width x height	8 x 30 mm
Standard lengths	708, 833, 958, 1083, 1208 mm
Minimum lengths*	235 mm
Maximum lengths	2000 mm
Can be shortened by	125 mm
Travel	20 mm

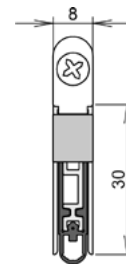

### FIXING/MONTAGE

Fixing	rebated into a groove in the door, screw fixed either side
Accessories included with delivery	5820

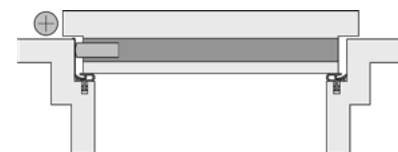

### PERFORMANCE & CERTIFICATES

Fire	UL 10C (R38166)
------	-----------------

\* min. lengths cannot be shortened



# M-12/12 RS

## 1-744

- / small installation dimensions
- / fits in the euro groove of profile doors

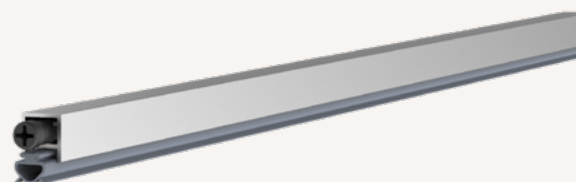

### TECHNICAL DATA

Application	hinged timber & PVC doors
Actuation	single
Gasket material	TPE

### DIMENSIONS

Width x height	11,8 x 17,8 mm
Standard lengths	customized
Minimum lengths*	320 mm
Maximum lengths	1600 mm
Can be shortened by	125 mm, smallest product length that can be shortened: 441 mm
Travel	8 mm

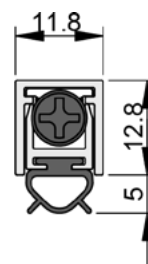

### FIXING/MONTAGE

Fixing	screw fixed into the chamber at the underside of the door
Accessories included with delivery	S016

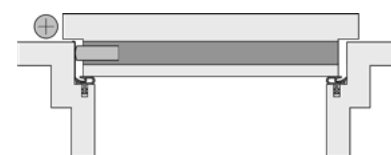

\* min. lengths cannot be shortened

# M-12/20 RS

## 1-723

- / hinged timber door drop seal
- / slimline design and lightweight operation

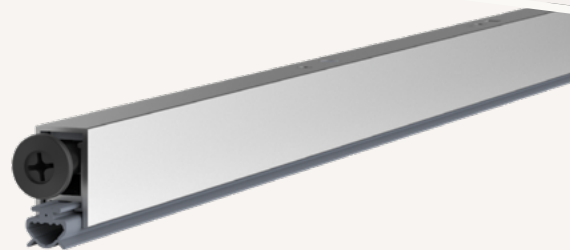

### TECHNICAL DATA

Application	hinged timber doors
Actuation	single
Gasket material	TPE

### DIMENSIONS

Width x height	11,8 x 20 mm
Standard lengths	customized
Minimum lengths*	260 mm
Maximum lengths	1525 mm
Can be shortened by	150 mm, smallest product length that can be shortened: 435 mm
Travel	12 mm

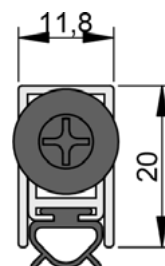

### FIXING/MONTAGE

Fixing	rebated into a groove in the door, screw fixed to the underside
Accessories included with delivery	S011

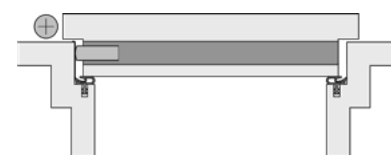

### PERFORMANCE & CERTIFICATES

Acoustic	35dB over 5mm gap, 33dB over 10mm gap
----------	---------------------------------------

\* min. lengths cannot be shortened

# M-12/30 RS

## 1-725

- / hinged timber door drop seal
- / slimline design and lightweight operation



### TECHNICAL DATA

Application	hinged timber doors
Actuation	single
Gasket material	TPE

### DIMENSIONS

Width x height	11,8 x 30 mm
Standard lengths	customized
Minimum lengths*	320 mm
Maximum lengths	1530 mm
Can be shortened by	125 mm, smallest product length that can be shortened: 445 mm
Travel	15 mm

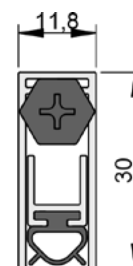

### FIXING/MONTAGE

Fixing	rebated into a groove in the door, screw fixed to the underside
Accessories included with delivery	S011

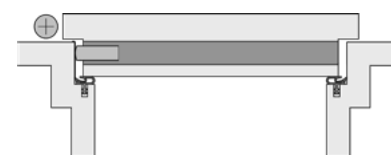

### PERFORMANCE & CERTIFICATES

Acoustic	37dB over 4mm gap, 33dB over 10mm gap
----------	---------------------------------------

\* min. lengths cannot be shortened





# M-12/28 OS

## 1-755

- / hinged timber door drop seal
- / slimline design and lightweight operation



### TECHNICAL DATA

Application	hinged timber doors
Actuation	single
Gasket material	silicone

### DIMENSIONS

Width x height	11,8 x 28 mm
Standard lengths	customized
Minimum lengths*	320 mm
Maximum lengths	1530 mm
Can be shortened by	125 mm, smallest product length that can be shortened: 445 mm
Travel	13 mm

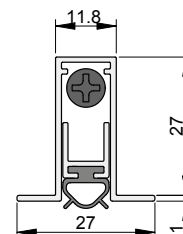

### FIXING/MONTAGE

Fixing	rebated into a groove in the door, screw fixed to the underside
Accessories included with delivery	S027

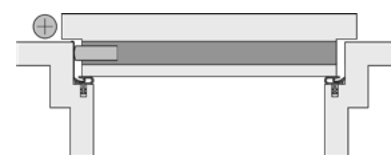

### PERFORMANCE & CERTIFICATES

Acoustic	37dB over 4mm gap, 33dB over 10mm gap
----------	---------------------------------------

**2 Drop seals**  
2.1 rebated drop seals for hinged doors

# M-12/30 EK

## 1-726

- / hinged timber door drop seal
- / slimline design and lightweight operation
- / end plates provide neat finish



### TECHNICAL DATA

Application	hinged timber doors
Actuation	single
Gasket material	TPE

### DIMENSIONS

Width x height	11,8 x 30 mm
Standard lengths	customized
Minimum lengths*	320 mm
Maximum lengths	1530 mm
Can be shortened by	125 mm, smallest product length that can be shortened: 445 mm
Travel	15 mm

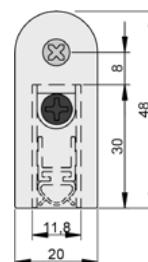

### FIXING/MONTAGE

Fixing	rebated into a groove in the door, screw fixed either side
Accessories included with delivery	S005

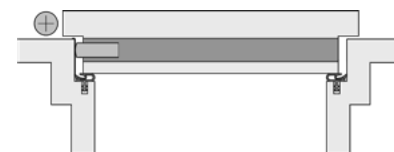

### PERFORMANCE & CERTIFICATES

Acoustic	37dB over 4mm gap, 33dB over 10mm gap
----------	---------------------------------------

\* min. lengths cannot be shortened



# Isolporte Standard

**1-153**

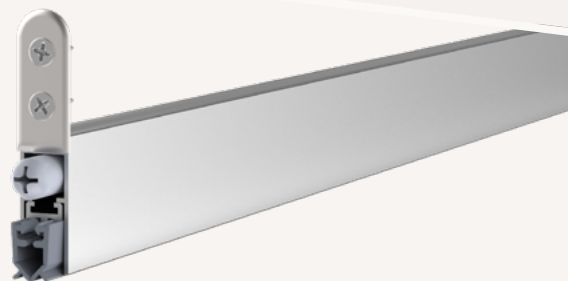

## TECHNICAL DATA

Application	hinged timber doors
Actuation	single
Gasket material	self-extinguishing silicone

## DIMENSIONS

Width x height	12 x 31 mm
Standard lengths	customized
Minimum lengths*	280 mm
Maximum lengths	1335 mm
Can be shortened by	125 mm
Travel	12 mm

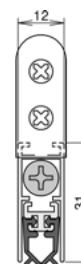

## FIXING/MONTAGE

Fixing	rebated into a groove in the door, screw fixed either side
Accessories included with delivery	7320

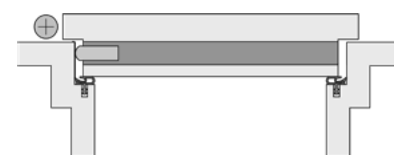

\* min. lengths cannot be shortened

**2 Drop seals**  
2.1 rebated drop seals for hinged doors

athmer.com

# Isolporte Omega

1-147



## TECHNICAL DATA

Application	hinged timber doors
Actuation	single
Gasket material	self-extinguishing silicone

## DIMENSIONS

Width x height	12 x 28 mm
Standard lengths	customized
Minimum lengths*	280 mm
Maximum lengths	1335 mm
Can be shortened by	125 mm
Travel	12 mm

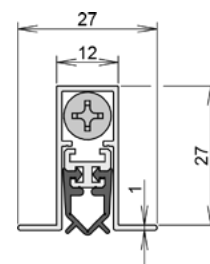

## FIXING/MONTAGE

Fixing	rebated into a groove in the door, screw fixed to the underside
Accessories included with delivery	7503

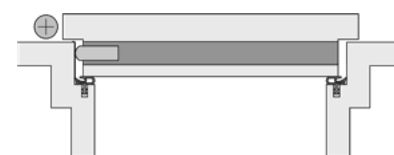

\* min. lengths cannot be shortened



# Doppeldicht M-12/35

## 1-392

- / slimline profile drop seal
- / deeper grooves up to 40mm possible
- / also available with DUO double actuation



### TECHNICAL DATA

Application	hinged timber doors
Actuation	single
Gasket material	self-extinguishing silicone

### DIMENSIONS

Width x height	12 x 35 mm
Standard lengths	708, 833, 958, 1083, 1208 mm
Minimum lengths*	220 mm
Maximum lengths	1335 mm
Can be shortened by	125 mm from standard lengths
Travel	11 mm

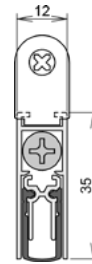

### FIXING/MONTAGE

Fixing	rebated into a groove in the door, screw fixed either side
Accessories included with delivery	5220

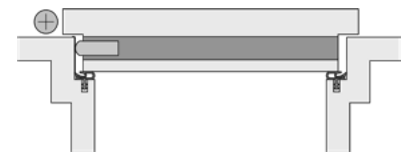

### PERFORMANCE & CERTIFICATES

Fire	UL10B & UL10C (R38166)
Acoustic	49dB over 7mm gap, 46dB over 10mm gap

\* min. lengths cannot be shortened

2 Drop seals  
2.1 rebated drop seals for hinged doors



# Schall-Ex® L-14/35 EK

## 1-935

- / drop seal with common groove dimension
- / parallel drop minimises friction with the floor
- / tool-free actuator can be deactivated before building occupancy
- / actuator requires no protective press plate for the frame
- / end plates provide neat finish

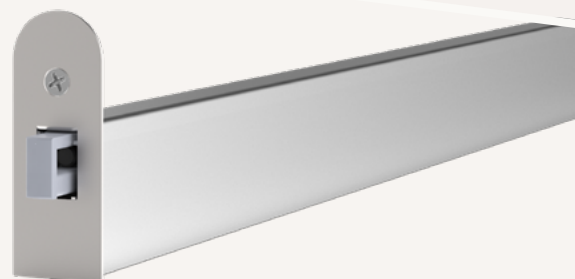

### TECHNICAL DATA

Application	hinged timber doors
Actuation	single
Gasket material	self-extinguishing silicone

### DIMENSIONS

Width x height	14 x 35 mm
Standard lengths	635, 735, 835, 935, 1035, 1135, 1235 mm
Minimum lengths*	235 mm
Maximum lengths	1635 mm
Can be shortened by	100 mm from standard lengths
Travel	20 mm

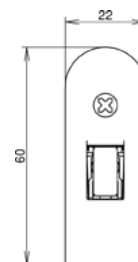

### FIXING/MONTAGE

Fixing	rebated into a groove in the door, screw fixed either side
Accessories included with delivery	5519

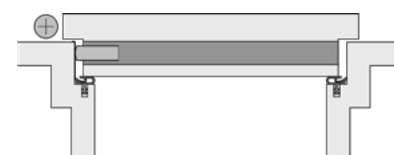

### PERFORMANCE & CERTIFICATES

Fire	EN 1634-1**, UL10B & UL10C (R38166)
Acoustic	51dB over 7mm gap, 44dB over 12mm gap
Smoke	Certifire TS21 (CF 5675)

\* min. lengths cannot be shortened

\*\*The test value may differ according to the EN 1634-1 test, as the complete door system must be checked.



# M-15/30 EK

## 1-741

- / hinged timber door drop seal
- / also available with duo double actuation
- / end plates provide neat finish



### TECHNICAL DATA

Application	hinged timber doors
Actuation	single
Gasket material	self-extinguishing silicone

### DIMENSIONS

Width x height	14,8 x 30 mm
Standard lengths	customized
Minimum lengths*	235 mm
Maximum lengths	1900 mm
Can be shortened by	125 mm, smallest product length that can be shortened: 708 mm
Travel	11 mm

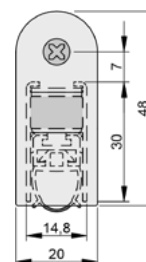

### FIXING/MONTAGE

Fixing	rebated into a groove in the door, screw fixed either side
Accessories included with delivery	S014

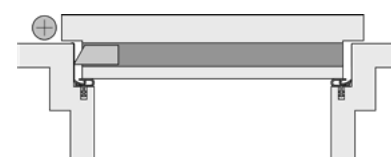

### PERFORMANCE & CERTIFICATES

Fire	UL 10C [R38166], EN 1634-1**
Acoustic	44dB over 7mm gap, 42dB over 10mm gap

### FURTHER VARIANTS

double actuation (techn. data may differ)	1-740
black end cap	1-749

\* min. lengths cannot be shortened

\*\*The test value may differ according to the EN 1634-1 test, as the complete door system must be checked.

2 Drop seals  
2.1 rebated drop seals for hinged doors

athmer.com



# M-15/30 WS

## 1-185

- / the classic timber door drop seal
- / hinged timber door drop seal
- / also available with double actuation

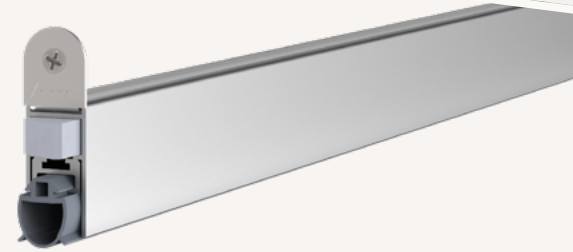

### TECHNICAL DATA

Application	hinged timber doors
Actuation	single
Gasket material	self-extinguishing silicone

### DIMENSIONS

Width x height	14,8 x 30 mm
Standard lengths	customized
Minimum lengths*	235 mm
Maximum lengths	1900 mm
Can be shortened by	125 mm, smallest product length that can be shortened: 708 mm
Travel	11 mm



### FIXING/MONTAGE

Fixing	rebated into a groove in the door, screw fixed either side
Accessories included with delivery	S002

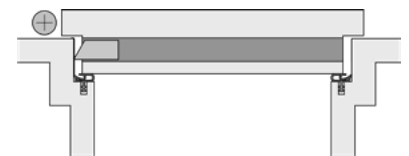

### PERFORMANCE & CERTIFICATES

Fire	UL 10C [R38166], EN 1634-1**
Acoustic	44dB over 7mm gap, 42dB over 10mm gap

### FURTHER VARIANTS

double actuation 1-184  
 (techn. data may differ)

\* min. lengths cannot be shortened

\*\*The test value may differ according to the EN 1634-1 test, as the complete door system must be checked.





# M-15/28 OS

## 1-179

- / hinged timber door drop seal
- / also available with double actuation



### TECHNICAL DATA

Application	hinged timber doors
Actuation	single
Gasket material	self-extinguishing silicone

### DIMENSIONS

Width x height	14,8 x 28 mm
Standard lengths	customized
Minimum lengths*	235 mm
Maximum lengths	1900 mm
Can be shortened by	125 mm, smallest product length that can be shortened: 708 mm
Travel	11 mm

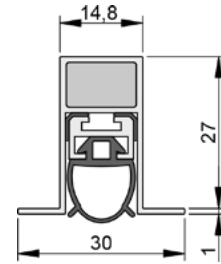

### FIXING/MONTAGE

Fixing	rebated into a groove in the door, screw fixed to the underside
Accessories included with delivery	S001

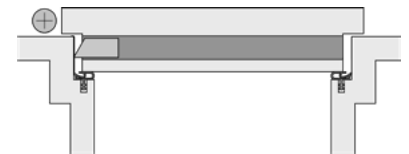

### PERFORMANCE & CERTIFICATES

Fire	UL 10C (R38166), EN 1634-1**
Acoustic	44dB over 7mm gap, 42dB over 10mm gap

### FURTHER VARIANTS

double actuation 1-178  
 (techn. data may differ)

\* min. lengths cannot be shortened

\*\*The test value may differ according to the EN 1634-1 test, as the complete door system must be checked.

2 Drop seals  
 2.1 rebated drop seals for hinged doors

athmer.com



## NEW GENERATION

- / The latest generation introduces an industry-wide benchmark with regard to quality and performance for timber doors

## UNCOMPROMISED ACOUSTIC PERFORMANCE

- / Designed with the latest technology to reduce sound flanking and achieve the highest performance over a range of gaps

# SCHALL-EX<sup>®</sup> L-15

THE STATE  
OF THE ART  
DROP SEAL

## CERTIFIED QUALITY

- / Testing and auditing from world-leading third-party certification schemes provide confidence in L-15's product quality and consistency

## DURABILITY YOU CAN DEPEND ON

- / L-15's host of new features including parallel drop protect the seal and door frame from damage and reduce sealing friction

## FLUSH BOLT INTEGRATION

- / Schall-Ex® L-15 can be integrated with a flush bolt, maintaining optimal acoustic performance on double doors



# Schall-Ex® L-15/30 EK

## 1-1017

- / the state of the art drop seal
- / parallel drop minimises friction with the floor
- / tool-free actuator can be deactivated before building occupancy
- / actuator requires no protective press plate for the frame
- / no lateral travel during actuation enhances



### TECHNICAL DATA

Application	hinged timber doors
Actuation	single
Gasket material	self-extinguishing silicone

### DIMENSIONS

Width x height	14,8 x 30 mm
Standard lengths	708, 833, 958, 1083, 1208 mm
Minimum lengths*	235 mm
Maximum lengths	2000 mm
Can be shortened by	125 mm from standard lengths
Travel	20 mm

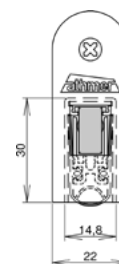

### FIXING/MONTAGE

Fixing	rebated into a groove in the door, screw fixed either side
Accessories included with delivery	5205

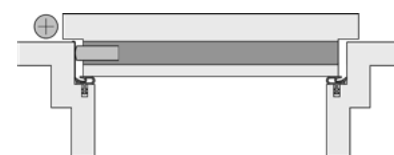

### PERFORMANCE & CERTIFICATES

Fire	EN 1634-1**
Acoustic	52dB over 7mm gap, 51dB over 12mm gap

\* min. lengths cannot be shortened

\*\*The test value may differ according to the EN 1634-1 test, as the complete door system must be checked.





# Schall-Ex® L-15/30 WS

## 1-880

- / the state of the art drop seal
- / parallel drop minimises friction with the floor
- / tool-free actuator can be deactivated before building occupancy
- / actuator requires no protective press plate for the frame
- / no lateral travel during actuation enhances



### TECHNICAL DATA

Application	hinged timber & metal doors
Actuation	single
Gasket material	self-extinguishing silicone

### DIMENSIONS

Width x height	14,8 x 30 mm
Standard lengths	708, 833, 958, 1083, 1208 mm
Minimum lengths*	235 mm
Maximum lengths	2000 mm
Can be shortened by	125 mm from standard lengths
Travel	20 mm

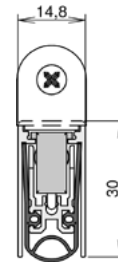

### FIXING/MONTAGE

Fixing	rebated into a groove in the door, screw fixed either side
Accessories included with delivery	5382

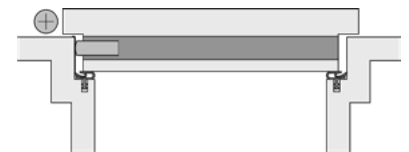

### PERFORMANCE & CERTIFICATES

Fire	EN 1634-1**, UL 10B & 10C (R38166)
Acoustic	52dB over 7mm gap, 51dB over 12mm gap
Smoke	Certifire TS21 (CF 5675)

### FURTHER VARIANTS

double actuation 1-382  
 (techn. data may differ)

\* min. lengths cannot be shortened

\*\*The test value may differ according to the EN 1634-1 test, as the complete door system must be checked.

2 Drop seals  
2.1 rebated drop seals for hinged doors

athmer.com

# Schall-Ex® L-15/30 OS

## 1-881

- / the state of the art drop seal
- / parallel drop minimises friction with the floor
- / tool-free actuator can be deactivated before building occupancy
- / actuator requires no protective press plate for the frame
- / no lateral travel during actuation enhances gasket position



### TECHNICAL DATA

Application	hinged timber & metal doors
Actuation	single
Gasket material	self-extinguishing silicone

### DIMENSIONS

Width x height	14,8 x 30 mm
Standard lengths	708, 833, 958, 1083, 1208 mm
Minimum lengths*	235 mm
Maximum lengths	2335 mm
Can be shortened by	125 mm from standard lengths
Travel	20 mm

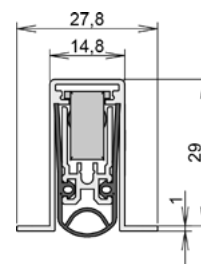

### FIXING/MONTAGE

Fixing	rebated into a groove in the door, screw fixed to the underside
--------	---

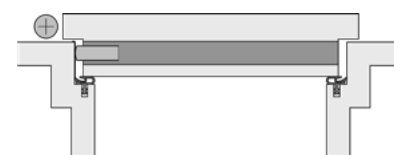

### PERFORMANCE & CERTIFICATES

Fire	EN 1634-1**, UL 10B & 10C (R38166)
Acoustic	52dB over 7mm gap, 51dB over 12mm gap
Smoke	Certifire TS21 (CF 5675)

\* min. lengths cannot be shortened

\*\*The test value may differ according to the EN 1634-1 test, as the complete door system must be checked.





# L-15/38 WS

## 1-172

/ hinged timber door drop seal



### TECHNICAL DATA

Application	hinged timber doors, hinged timber gates
Actuation	single
Gasket material	self-extinguishing silicone

### DIMENSIONS

Width x height	14,8 x 38 mm
Standard lengths	customized
Minimum lengths*	300 mm
Maximum lengths	1700 mm
Can be shortened by	125 mm, smallest product length that can be shortened: 461 mm
Travel	20 mm

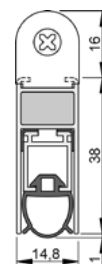

### FIXING/MONTAGE

Fixing	rebated into a groove in the door, screw fixed either side
Accessories included with delivery	S002

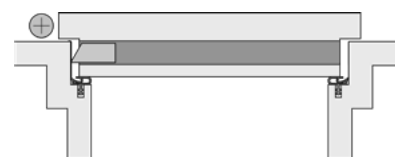

### PERFORMANCE & CERTIFICATES

Fire	EN 1634-1**
Acoustic	43dB over 7mm gap, 42dB over 10mm gap, 39dB over 15mm gap

\* min. lengths cannot be shortened

\*\*The test value may differ according to the EN 1634-1 test, as the complete door system must be checked.

# L-15/35 OS

## 1-169

/ hinged timber door drop seal



### TECHNICAL DATA

Application	hinged timber doors, hinged timber gates
Actuation	single
Gasket material	self-extinguishing silicone

### DIMENSIONS

Width x height	14,8 x 35 mm
Standard lengths	customized
Minimum lengths*	300 mm
Maximum lengths	2000 mm
Can be shortened by	125 mm, smallest product length that can be shortened: 461 mm
Travel	20 mm

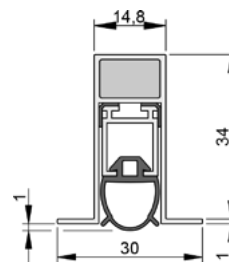

### FIXING/MONTAGE

Fixing	rebated into a groove in the door, screw fixed to the underside
Accessories included with delivery	S001

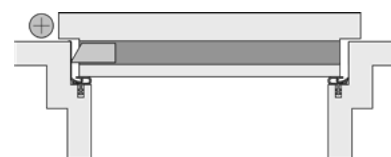

### PERFORMANCE & CERTIFICATES

Fire	EN 1634-1**
Acoustic	43dB over 7mm gap, 42dB over 10mm gap, 39dB over 15mm gap

\* min. lengths cannot be shortened

\*\*The test value may differ according to the EN 1634-1 test, as the complete door system must be checked.



# Schall-Ex® Ultra

## 1-291

- / corrosion-resistant drop seal
- / salt spray tested to EN 1670, Class 5 (480 hours)
- / ideal for use in high humidity environments
- / overload protection protects seal from excessive wear
- / also available with double actuation

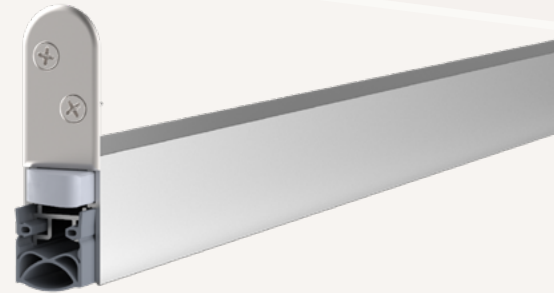

### TECHNICAL DATA

Application	hinged timber & metal doors, hinged timber & metal gates
Actuation	single
Gasket material	self-extinguishing silicone

### DIMENSIONS

Width x height	19,7 x 30 mm
Standard lengths	708, 833, 958, 1083, 1208 mm
Minimum lengths*	220 mm
Maximum lengths	2000 mm
Can be shortened by	125 mm from standard lengths
Travel/Hub	12 mm

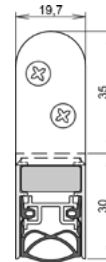

### FIXING/MONTAGE

Fixing	rebated into a groove in the door, screw fixed either side
Accessories included with delivery	5610

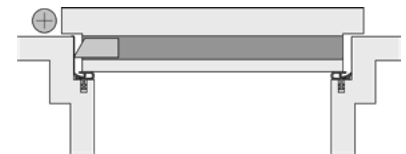

### PERFORMANCE & CERTIFICATES

Fire	UL10B & UL10C (R31866)
Smoke	Certifire TS21 (CF 5675) Acoustic: 51dB over 7mm gap

### FURTHER VARIANTS

double actuation 1-290  
 [techn. data may differ]

\* min. lengths cannot be shortened

2 Drop seals  
 2.1 rebated drop seals for hinged doors

athmer.com



# Schall-Ex® Ultra OS

## 1-293

- / corrosion-resistant drop seal
- / salt spray tested to EN 1670, Class 5 (480 hours)
- / ideal for use in high humidity environments
- / overload protection protects seal from excessive wear
- / also available with double actuation



### TECHNICAL DATA

Application	hinged timber & metal doors, hinged timber & metal gates
Actuation	single
Gasket material	self-extinguishing silicone

### DIMENSIONS

Width x height	19,7 x 30 mm
Standard lengths	708, 833, 958, 1083, 1208 mm
Minimum lengths*	220 mm
Maximum lengths	2000 mm
Can be shortened by	125 mm from standard lengths
Travel	12 mm

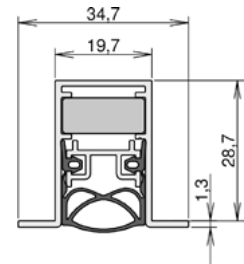

### FIXING/MONTAGE

Fixing	rebated into a groove in the door, screw fixed to the underside
Accessories included with delivery	5503

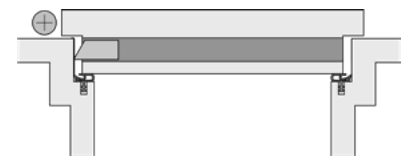

### PERFORMANCE & CERTIFICATES

Fire	UL10B & UL10C (R31866)
Smoke	Certifire TS21 (CF 5675) Acoustic: 51dB over 7mm gap

### FURTHER VARIANTS

double actuation 1-292  
 (techn. data may differ)

\* min. lengths cannot be shortened

2 Drop seals  
 2.1 rebated drop seals for hinged doors

athmer.com

# Schall-Ex® Radiation Protection WS

## 1-529

- / radiation-resistant drop seal
- / suitable for use with radiation protection doors in accordance with DIN 6834
- / lead-lined gasket perfect for medical use in x-ray rooms, etc.
- / also available with double actuation



### TECHNICAL DATA

Application	hinged timber doors
Actuation	single
Gasket material	self-extinguishing silicone, lead rubber

### DIMENSIONS

Width x height	19,7 x 30 mm
Standard lengths	708, 833, 958, 1083, 1208 mm
Minimum lengths*	220 mm
Maximum lengths	2000 mm
Can be shortened by	125 mm
Travel	12 mm

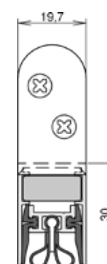

### FIXING/MONTAGE

Fixing	rebated into a groove in the door, screw fixed either side
Accessories included with delivery	5610

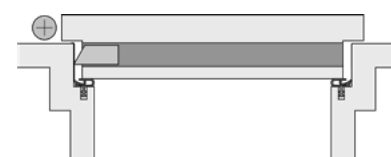

### FURTHER VARIANTS

double actuation 1-528  
[techn. data may differ]

\* min. lengths cannot be shortened

# Schall-Ex® Radiation Protection WS BD

## 1-521

- / radiation-resistant drop seal
- / suitable for use with radiation protection doors in accordance with DIN 6834
- / lead-lined gasket perfect for medical use in x-ray rooms, etc.
- / also available with double actuation



### TECHNICAL DATA

Application	hinged timber doors
Actuation	single
Gasket material	silicone self-extinguishing, lead rubber

### DIMENSIONS

Width x height	19,7 x 30 mm
Standard lengths	708, 833, 958, 1083, 1208 mm
Minimum lengths*	220 mm
Maximum lengths	2000 mm
Can be shortened by	125 mm from standard lengths
Travel	12 mm

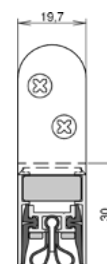

### FIXING/MONTAGE

Fixing	rebated into a groove in the door, screw fixed either side
Accessories included with delivery	5610

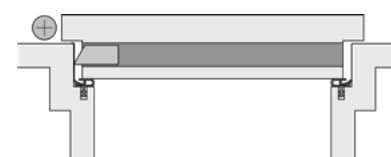

### FURTHER VARIANTS

double actuation 1-522  
[techn. data may differ]

\* min. lengths cannot be shortened



# Schall-Ex® Radiation Protection OS

## 1-295

- / radiation-resistant drop seal
- / suitable for use with radiation protection doors in accordance with DIN 6834
- / lead-lined gasket perfect for medical use in x-ray rooms, etc.
- / also available with double actuation

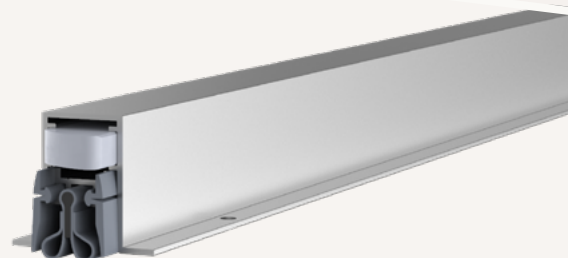

### TECHNICAL DATA

Application	hinged timber & metal doors
Actuation	single
Gasket material	silicone self-extinguishing, lead rubber

### DIMENSIONS

Width x height	19,7 x 30 mm
Standard lengths	708, 833, 958, 1083, 1208 mm
Minimum lengths*	708 mm
Maximum lengths	1500 mm
Can be shortened by	125 mm from standard lengths
Travel	12 mm

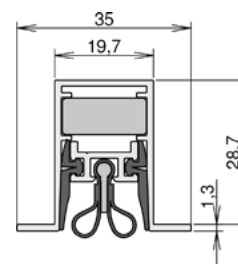

### FIXING/MONTAGE

Fixing	rebated into a groove in the door, screw fixed to the underside
Accessories included with delivery	5420

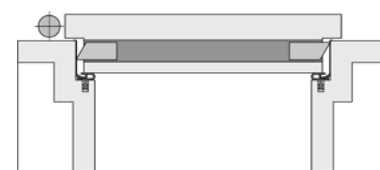

### FURTHER VARIANTS

double actuation 1-294  
(techn. data may differ)

\* min. lengths cannot be shortened

# Schall-Ex® Radiation Protection OS BD

## 1-519

- / radiation-resistant drop seal
- / suitable for use with radiation protection doors in accordance with DIN 6834
- / lead-lined gasket perfect for medical use in x-ray rooms, etc.
- / also available with double actuation

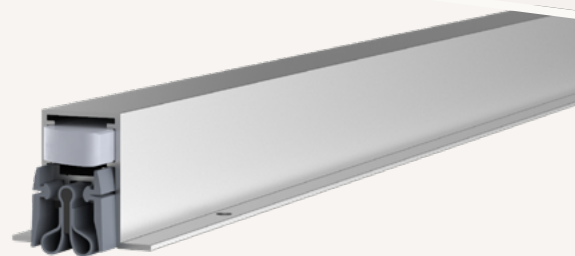

### TECHNICAL DATA

Application	hinged timber doors
Actuation	single
Gasket material	silicone self-extinguishing, lead rubber

### DIMENSIONS

Width x height	19,7 x 30 mm
Standard lengths	708, 833, 958, 1083, 1208 mm
Minimum lengths*	220 mm
Maximum lengths	2000 mm
Can be shortened by	125 mm from standard lengths
Travel	12 mm

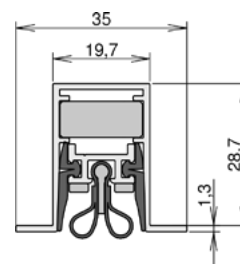

### FIXING/MONTAGE

Fixing	rebated into a groove in the door, screw fixed to the underside
Accessories included with delivery	5503

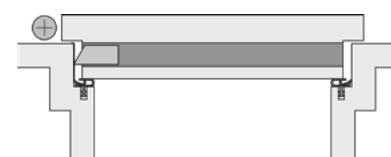

### FURTHER VARIANTS

double actuation 1-520  
[techn. data may differ]

\* min. lengths cannot be shortened







## **MODULAR COMPONENTS FOR GREATER FLEXIBILITY**

- / Wide range of sizes and fixing variations based on the same mechanical philosophy for more flexibility in predetermined spaces

## **SUITABLE FOR ALL MATERIAL TYPES**

- / Suitable for system doors made from various types of material - including PVC, steel and aluminium

# STADI

## THE MODULAR SYSTEM DOOR SEAL



### QUALITY YOU CAN DEPEND ON

- / Confidence in Stadi's product quality and consistency is provided by testing and auditing from world-leading third-party certification schemes

### IMPROVED DURABILITY

- / Stadi's host of new features including overload protection protect the seal and door frame from damage and reduce sealing friction

### FLUSH BOLT INTEGRATION

- / All size options can be integrated with a flush bolt, maintaining optimum acoustic performance on double doors

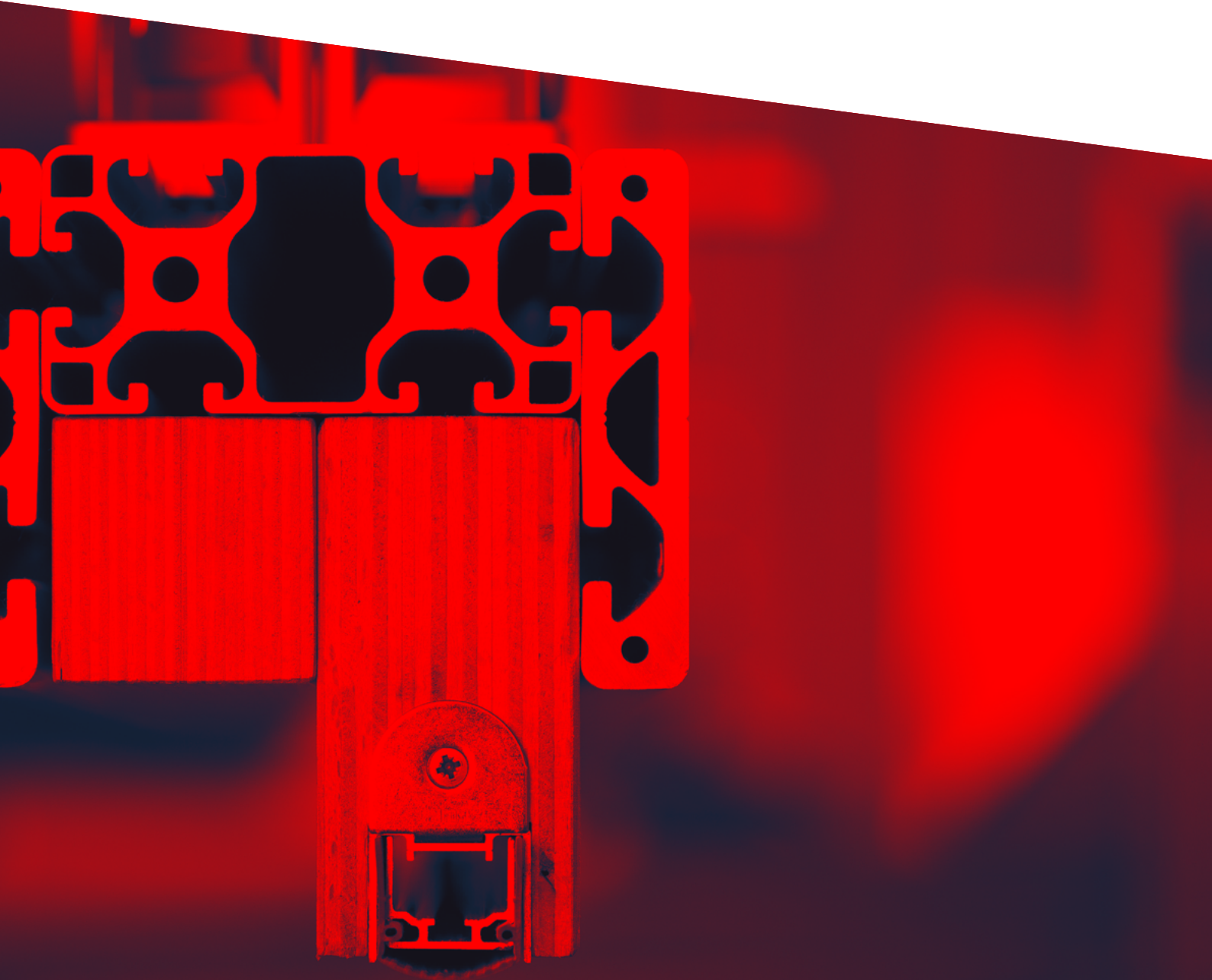

# Stadi M-17/17 WS

## 1-937

- / the modular system door seal
- / parallel drop minimises friction with the floor
- / tool-free actuator can be deactivated before building occupancy
- / actuator requires no protective press plate for the frame
- / overload protection protects seal from excessive wear



### TECHNICAL DATA

Application	hinged timber & metal & PVC doors
Actuation	single
Gasket material	self-extinguishing silicone

### DIMENSIONS

Width x height	17 x 17 mm
Standard lengths	750, 900, 1050, 1200 mm
Minimum lengths*	250 mm
Maximum lengths	2000 mm
Can be shortened by	150 mm from standard lengths
Travel	13 mm

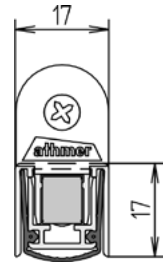

### FIXING/MONTAGE

Fixing	into the chamber at underside of the door, screw fixed either side
Accessories included with delivery	5104

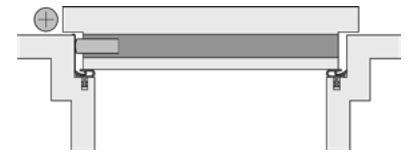

### PERFORMANCE & CERTIFICATES

Fire	UL10B & UL10C (R38166)
Acoustic	52dB over 12mm gap

\* min. lengths cannot be shortened







# Stadi MD-17/17 WS

## 1-950

- / the modular system door seal
- / parallel drop minimises friction with the floor
- / tool-free actuator can be deactivated before building occupancy
- / actuator requires no protective press plate for the frame
- / overload protection protects seal from excessive wear

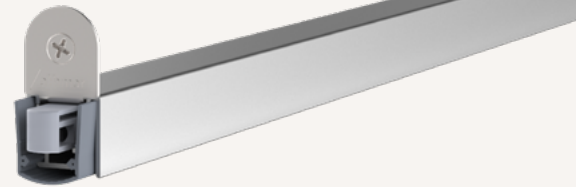

### TECHNICAL DATA

Application	hinged timber & metal & PVC doors
Actuation	single, delayed actuation
Gasket material	self-extinguishing silicone

### DIMENSIONS

Width x height	17 x 17 mm
Standard lengths	750, 900, 1050, 1200 mm
Minimum lengths*	655 mm
Maximum lengths	2000 mm
Can be shortened by	150 mm from standard lengths
Travel	13 mm

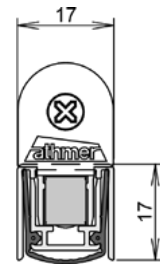

### FIXING/MONTAGE

Fixing	into the chamber at underside of the door, screw fixed either side
Accessories included with delivery	5428

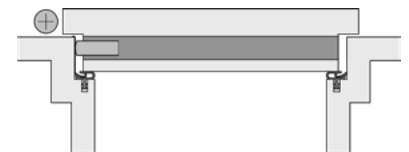

### PERFORMANCE & CERTIFICATES

Fire	UL10B & UL10C (R38166)
Acoustic	52dB over 12mm gap

\* min. lengths cannot be shortened

2 Drop seals  
2.1 rebated drop seals for hinged doors

athmer.com





# Stadi L-17/20 WS

## 1-940

- / the modular system door seal
- / parallel drop minimises friction with the floor
- / tool-free actuator can be deactivated before building occupancy
- / actuator requires no protective press plate for the frame
- / overload protection protects seal from excessive wear



### TECHNICAL DATA

Application	hinged timber & metal & PVC doors
Actuation	single
Gasket material	self-extinguishing silicone

### DIMENSIONS

Width x height	17 x 20 mm
Standard lengths	750, 900, 1050, 1200 mm
Minimum lengths*	250 mm
Maximum lengths	2000 mm
Can be shortened by	150 mm from standard lengths
Travel	16 mm

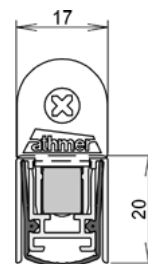

### FIXING/MONTAGE

Fixing	into the chamber at underside of the door, screw fixed either side
Accessories included with delivery	5104

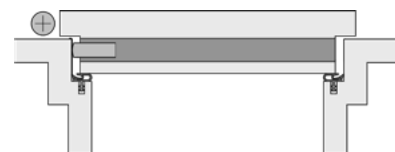

### PERFORMANCE & CERTIFICATES

Fire	UL10B & UL10C (R38166)
Acoustic	52dB over 7mm gap, 51dB over 12mm gap
Smoke	Certifire TS21 (CF 5675)

\* min. lengths cannot be shortened



# Stadi LD-17/20 WS

## 1-953

- / the modular system door seal
- / parallel drop minimises friction with the floor
- / tool-free actuator can be deactivated before building occupancy
- / actuator requires no protective press plate for the frame
- / overload protection protects seal from excessive wear



### TECHNICAL DATA

Application	hinged timber & metal & PVC doors
Actuation	single, delayed actuation
Gasket material	self-extinguishing silicone

### DIMENSIONS

Width x height	17 x 20 mm
Standard lengths	750, 900, 1050, 1200 mm
Minimum lengths*	655 mm
Maximum lengths	1600 mm
Can be shortened by	150 mm from standard lengths
Travel	16 mm

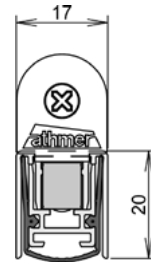

### FIXING/MONTAGE

Fixing	into the chamber at underside of the door, screw fixed either side
Accessories included with delivery	5428

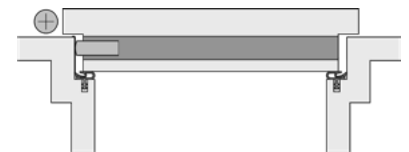

### PERFORMANCE & CERTIFICATES

Fire	UL10B & UL10C (R38166)
Acoustic	52dB over 7mm gap, 51dB over 12mm gap
Smoke	Certifire TS21 (CF 5675)

\* min. lengths cannot be shortened

2 Drop seals  
2.1 rebated drop seals for hinged doors

athmer.com





# Stadi L-20/20 WS

## 1-939

- / the modular system door seal
- / parallel drop minimises friction with the floor
- / tool-free actuator can be deactivated before building occupancy
- / actuator requires no protective press plate for the frame
- / overload protection protects seal from excessive wear



### TECHNICAL DATA

Application	hinged timber & metal & PVC doors
Actuation	single
Gasket material	self-extinguishing silicone

### DIMENSIONS

Width x height	20 x 20 mm
Standard lengths	750, 900, 1050, 1200 mm
Minimum lengths*	230 mm
Maximum lengths	2000 mm
Can be shortened by	150 mm from standard lengths
Travel	16 mm

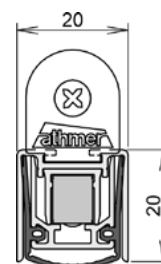

### FIXING/MONTAGE

Fixing	into the chamber at underside of the door, screw fixed either side
Accessories included with delivery	5104

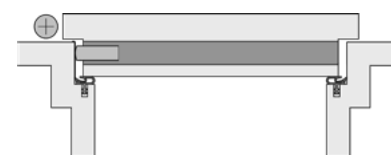

### PERFORMANCE & CERTIFICATES

Fire	UL10B & UL10C (R38166)
Acoustic	52dB over 12mm gap
Smoke	Certifire TS21 (CF 5675)

\* min. lengths cannot be shortened



# Stadi LD-20/20 WS

## 1-952

- / the modular system door seal
- / parallel drop minimises friction with the floor
- / tool-free actuator can be deactivated before building occupancy
- / actuator requires no protective press plate for the frame
- / overload protection protects seal from excessive wear



### TECHNICAL DATA

Application	hinged timber & metal & PVC doors
Actuation	single, delayed actuation
Gasket material	self-extinguishing silicone

### DIMENSIONS

Width x height	20 x 20 mm
Standard lengths	750, 900, 1050, 1200 mm
Minimum lengths*	635 mm
Maximum lengths	1600 mm
Can be shortened by	150 mm from standard lengths
Travel	16 mm

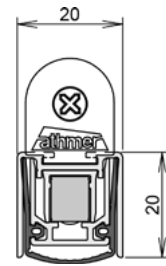

### FIXING/MONTAGE

Fixing	into the chamber at underside of the door, screw fixed either side
Accessories included with delivery	5428

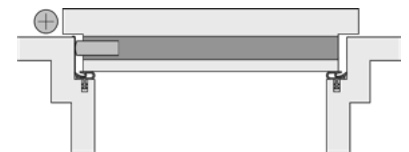

### PERFORMANCE & CERTIFICATES

Fire	UL10B & UL10C (R38166)
Acoustic	52dB over 12mm gap
Smoke	Certifire TS21 (CF 5675)

\* min. lengths cannot be shortened

# Stadi L-20/20 OS

## 1-972

- / the modular system door seal
- / parallel drop minimises friction with the floor
- / tool-free actuator can be deactivated before building occupancy
- / actuator requires no protective press plate for the frame
- / overload protection protects seal from excessive wear

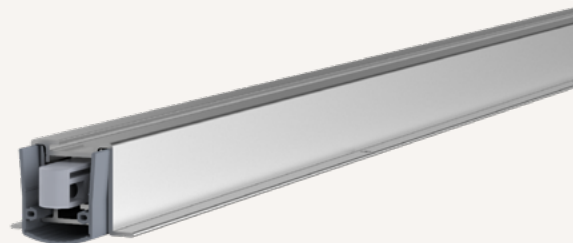

### TECHNICAL DATA

Application	hinged timber & metal & PVC doors
Actuation	single
Gasket material	self-extinguishing silicone

### DIMENSIONS

Width x height	20 x 20 mm
Standard lengths	750, 900, 1050, 1200 mm
Minimum lengths*	635 mm
Maximum lengths	1600 mm
Can be shortened by	150 mm from standard lengths
Travel	16 mm

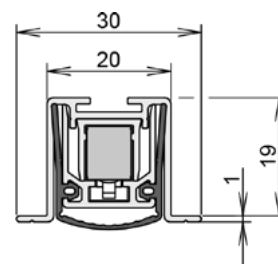

### FIXING/MONTAGE

Fixing	screw fixed into the chamber at the underside of the door
Accessories included with delivery	5503

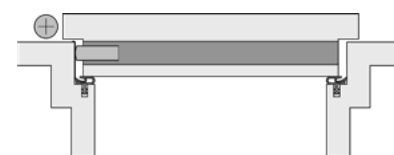

### PERFORMANCE & CERTIFICATES

Acoustic	52dB over 12mm gap
----------	--------------------

\* min. lengths cannot be shortened



# Stadi LD-20/20 OS

## 1-985

- / the modular system door seal
- / parallel drop minimises friction with the floor
- / tool-free actuator can be deactivated before building occupancy
- / actuator requires no protective press plate for the frame
- / overload protection protects seal from excessive wear

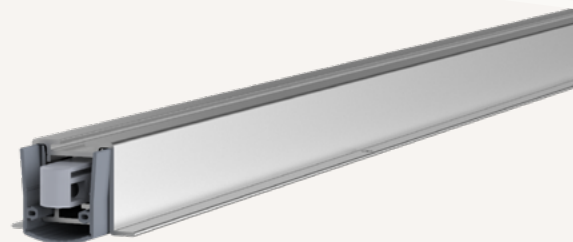

### TECHNICAL DATA

Application	hinged timber & metal & PVC doors
Actuation	single, delayed actuation
Gasket material	self-extinguishing silicone

### DIMENSIONS

Width x height	20 x 20 mm
Standard lengths	750, 900, 1050, 1200 mm
Minimum lengths*	635 mm
Maximum lengths	1600 mm
Can be shortened by	150 mm from standard lengths
Travel	16 mm

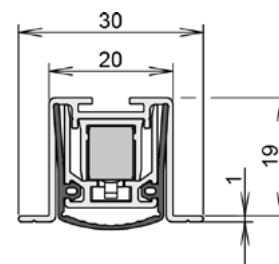

### FIXING/MONTAGE

Fixing	screw fixed into the chamber at the underside of the door
Accessories included with delivery	5503

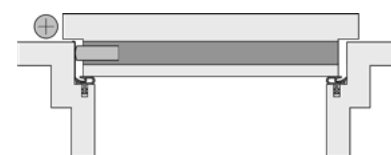

### PERFORMANCE & CERTIFICATES

Acoustic	52dB over 12mm gap
----------	--------------------

\* min. lengths cannot be shortened



# Stadi L-24/20 WS

## 1-938

- / the modular system door seal
- / parallel drop minimises friction with the floor
- / tool-free actuator can be deactivated before building occupancy
- / actuator requires no protective press plate for the frame
- / overload protection protects seal from excessive wear

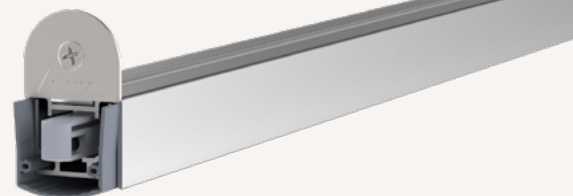

### TECHNICAL DATA

Application	hinged timber & metal & PVC doors
Actuation	single
Gasket material	self-extinguishing silicone

### DIMENSIONS

Width x height	24 x 20 mm
Standard lengths	750, 900, 1050, 1200 mm
Minimum lengths*	230 mm
Maximum lengths	2000 mm
Can be shortened by	150 mm from standard lengths
Travel	16 mm

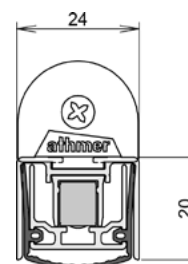

### FIXING/MONTAGE

Fixing	into the chamber at underside of the door, screw fixed either side
Accessories included with delivery	5302

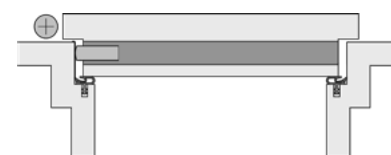

### PERFORMANCE & CERTIFICATES

Fire	UL10B & UL10C (R38166)
Acoustic	54dB over 7mm gap, 51dB over 12mm gap
Smoke	Certifire TS21 (CF 5675)

\* min. lengths cannot be shortened



# Stadi LD-24/20 WS

## 1-951

- / the modular system door seal
- / parallel drop minimises friction with the floor
- / tool-free actuator can be deactivated before building occupancy
- / actuator requires no protective press plate for the frame
- / overload protection protects seal from excessive wear

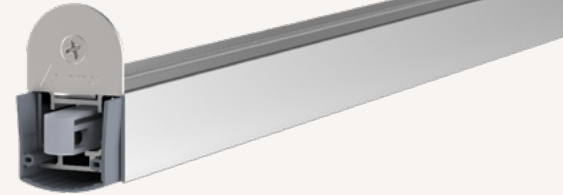

### TECHNICAL DATA

Application	hinged timber & metal & PVC doors
Actuation	single, delayed actuation
Gasket material	self-extinguishing silicone

### DIMENSIONS

Width x height	24 x 20 mm
Standard lengths	750, 900, 1050, 1200 mm
Minimum lengths*	635 mm
Maximum lengths	1600 mm
Can be shortened by	150 mm from standard lengths
Travel	16 mm

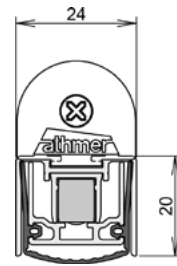

### FIXING/MONTAGE

Fixing	into the chamber at underside of the door, screw fixed either side
Accessories included with delivery	5427

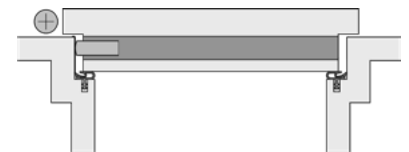

### PERFORMANCE & CERTIFICATES

Fire	UL10B & UL10C (R38166)
Acoustic	54dB over 7mm gap, 51dB over 12mm gap
Smoke	Certifire TS21 (CF 5675)

\* min. lengths cannot be shortened

2 Drop seals  
2.1 rebated drop seals for hinged doors

athmer.com



# Stadi L-24/20 OS

## 1-959

- / the modular system door seal
- / parallel drop minimises friction with the floor
- / tool-free actuator can be deactivated before building occupancy
- / actuator requires no protective press plate for the frame
- / overload protection protects seal from excessive wear

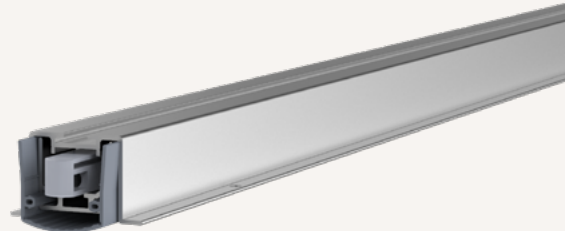

### TECHNICAL DATA

Application	hinged timber & metal & PVC doors
Actuation	single
Gasket material	self-extinguishing silicone

### DIMENSIONS

Width x height	24 x 20 mm
Standard lengths	750, 900, 1050, 1200 mm
Minimum lengths*	230 mm
Maximum lengths	3000 mm
Can be shortened by	150 mm from standard lengths
Travel	16 mm

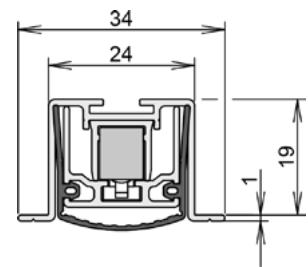

### FIXING/MONTAGE

Fixing	screw fixed into the chamber at the underside of the door
Accessories included with delivery	5503

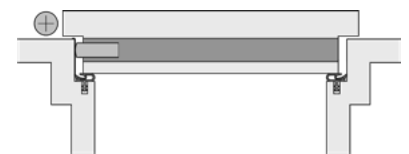

### PERFORMANCE & CERTIFICATES

Fire	UL10B & UL10C (R38166)
Acoustic	54dB over 7mm gap, 51dB over 12mm gap
Smoke	Certifire TS21 (CF 5675)

\* min. lengths cannot be shortened

# Stadi LD-24/20 OS

## 1-1025

- / the modular system door seal
- / parallel drop minimises friction with the floor
- / tool-free actuator can be deactivated before building occupancy
- / actuator requires no protective press plate for the frame
- / overload protection protects seal from excessive wear

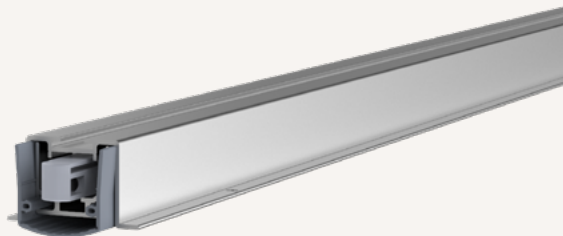

### TECHNICAL DATA

Application	hinged timber & metal & PVC doors
Actuation	single, delayed actuation
Gasket material	self-extinguishing silicone

### DIMENSIONS

Width x height	24 x 20 mm
Standard lengths	750, 900, 1050, 1200 mm
Minimum lengths*	230 mm
Maximum lengths	3000 mm
Can be shortened by	150 mm from standard lengths
Travel	16 mm

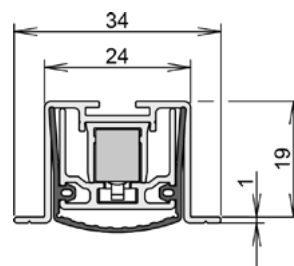

### FIXING/MONTAGE

Fixing	screw fixed into the chamber at the underside of the door
Accessories included with delivery	5503

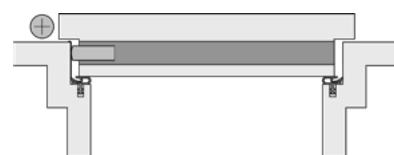

### PERFORMANCE & CERTIFICATES

Acoustic	54dB over 7mm gap, 51dB over 12mm gap
----------	---------------------------------------

\* min. lengths cannot be shortened

2 Drop seals  
2.1 rebated drop seals for hinged doors

athmer.com



# Stadi L-24/20 TS

## 1-960

- / the modular system door seal
- / parallel drop minimises friction with the floor
- / tool-free actuator can be deactivated before building occupancy
- / actuator requires no protective press plate for the frame
- / overload protection protects seal from excessive wear

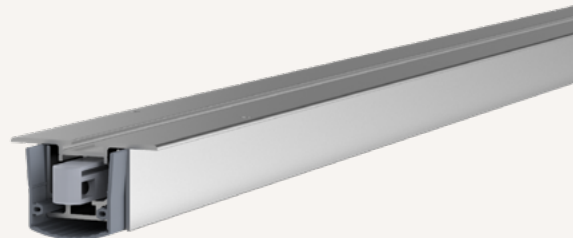

### TECHNICAL DATA

Application	hinged metal & PVC doors
Actuation	single
Gasket material	self-extinguishing silicone

### DIMENSIONS

Width x height	38 x 20 mm
Standard lengths	750, 900, 1050, 1200 mm
Minimum lengths*	230 mm
Maximum lengths	3000 mm
Can be shortened by	150 mm from standard lengths
Travel	16 mm

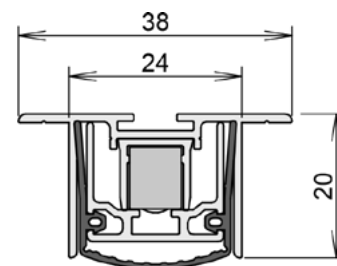

### FIXING/MONTAGE

Fixing	screw fixed into the chamber at the underside of the door
Accessories included with delivery	5503

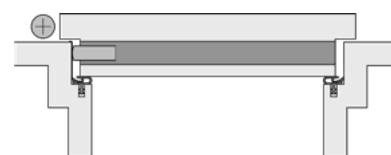

### PERFORMANCE & CERTIFICATES

Fire	UL10B & UL10C (R38166)
Acoustic	54dB over 7mm gap, 51dB over 12mm gap

\* min. lengths cannot be shortened



# Stadi LD-24/20 TS

## 1-1026

- / the modular system door seal
- / parallel drop minimises friction with the floor
- / tool-free actuator can be deactivated before building occupancy
- / actuator requires no protective press plate for the frame
- / overload protection protects seal from excessive wear

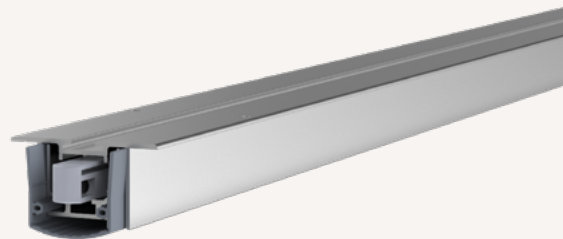

### TECHNICAL DATA

Application	hinged metal & PVC doors
Actuation	single, delayed actuation
Gasket material	self-extinguishing silicone

### DIMENSIONS

Width x height	38 x 20 mm
Standard lengths	750, 900, 1050, 1200 mm
Minimum lengths*	230 mm
Maximum lengths	3000 mm
Can be shortened by	150 mm from standard lengths
Travel	16 mm

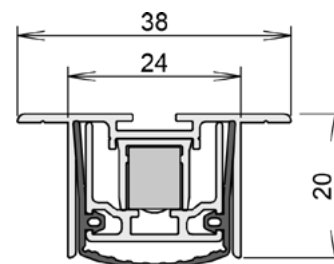

### FIXING/MONTAGE

Fixing	screw fixed into the chamber at the underside of the door
Accessories included with delivery	5503

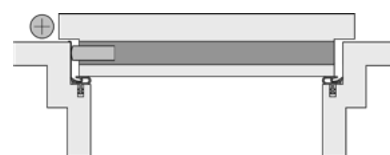

### PERFORMANCE & CERTIFICATES

Acoustic	54dB over 7mm gap, 51dB over 12mm gap
----------	---------------------------------------

\* min. lengths cannot be shortened

# Rainstop® L-24/20 WS

## 1-955

- / weatherproof drop seal
- / air permeability tested (EN 12207)
- / resistance to driving rain (EN 12208)
- / resistance to wind load (EN 12210)



### TECHNICAL DATA

Application	hinged timber & metal & PVC doors
Actuation	single
Gasket material	self-extinguishing silicone

### DIMENSIONS

Width x height	24 x 20 mm
Standard lengths	900, 975, 1050, 1125, 1200, 1275, 1350, 1425, 1500 mm
Minimum lengths*	230 mm
Maximum lengths	2000 mm
Can be shortened by	150 mm from standard lengths
Travel	16 mm

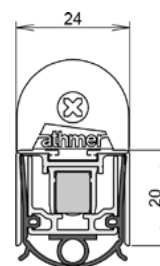

### FIXING/MONTAGE

Fixing	rebated into a groove in the door, screw fixed either side
Accessories included with delivery	5475

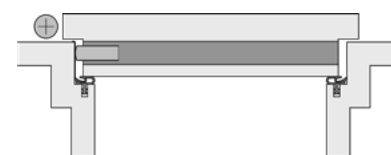

### PERFORMANCE & CERTIFICATES

Acoustic	54dB over 7mm gap
----------	-------------------

\* min. lengths cannot be shortened

# Stadi XL-40 ST

1-477



## TECHNICAL DATA

Application	hinged metal gates, sliding metal gates
Actuation	single
Gasket material	self-extinguishing silicone

## DIMENSIONS

Width x height	28,5 x 40 mm
Standard lengths	750, 900, 1050, 1200 mm
Minimum lengths*	600 mm
Maximum lengths	8000 mm
Can be shortened by	125 mm
Travel	20 mm

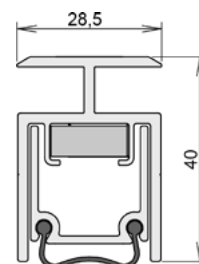

## FIXING/MONTAGE

Fixing	surface mounted to the face of the door, screw fixed
Accessories included with delivery	5962



\* min. lengths cannot be shortened

2 Drop seals  
2.1 rebated drop seals for hinged doors

athmer.com



# M-24/20 WS

## 1-264

/ the classic drop seal for aluminum, steel and PVC doors

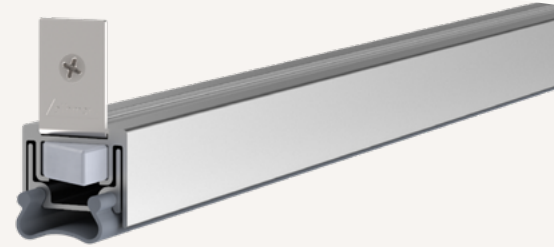

### TECHNICAL DATA

Application	hinged metal & PVC doors
Actuation	single
Gasket material	self-extinguishing silicone

### DIMENSIONS

Width x height	24 x 20 mm
Standard lengths	customized
Minimum lengths*	220 mm
Maximum lengths	2000 mm
Can be shortened by	125 mm, smallest product length that can be shortened: 676 mm
Travel	11 mm

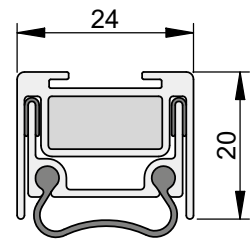

### FIXING/MONTAGE

Fixing	into the chamber at the underside of the door, screw fixed either side
Accessories included with delivery	S007

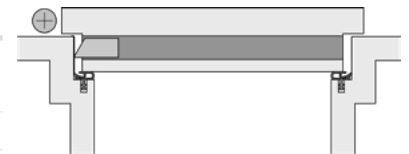

### PERFORMANCE & CERTIFICATES

Fire	UL 10C [R38166]
Acoustic	44dB over 7mm gap, 42dB over 10mm gap

\* min. lengths cannot be shortened



# M-24/21 OS

## 1-244

/ the classic drop seal for aluminum, steel and PVC doors

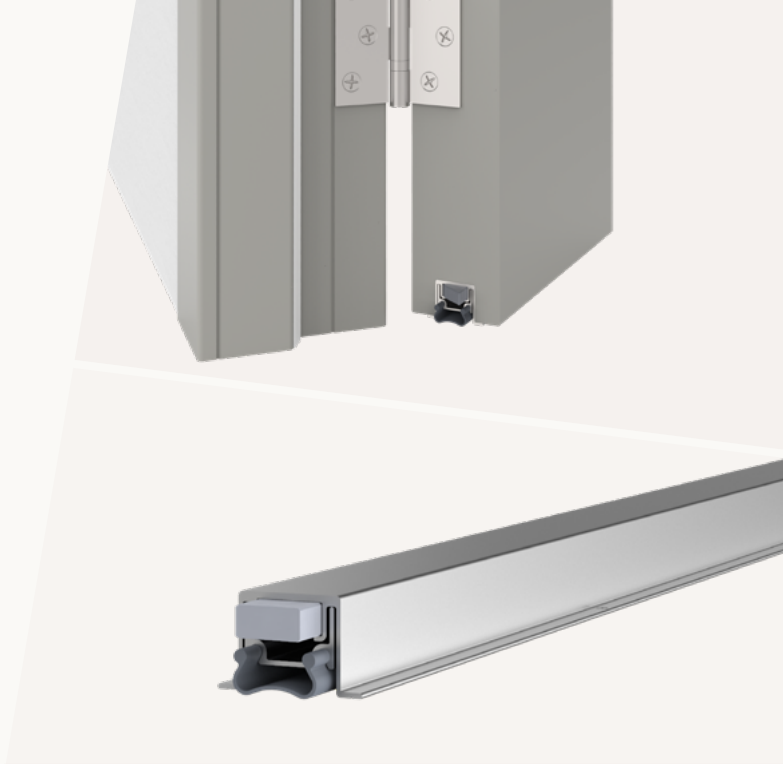

### TECHNICAL DATA

Application	hinged metal & PVC doors
Actuation	single
Gasket material	self-extinguishing silicone

### DIMENSIONS

Width x height	24 x 21 mm
Standard lengths	customized
Minimum lengths*	220 mm
Maximum lengths	2900 mm
Can be shortened by	125 mm, smallest product length that can be shortened: 676 mm
Travel	11 mm

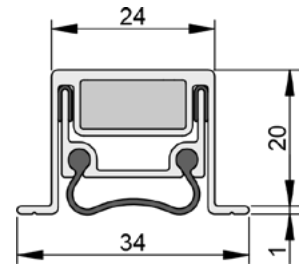

### FIXING/MONTAGE

Fixing	screw fixed into the chamber at the underside of the door
Accessories included with delivery	S008

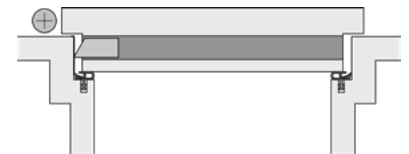

### PERFORMANCE & CERTIFICATES

Fire	UL 10C [R38166]
Acoustic	44dB over 7mm gap, 42dB over 10mm gap

\* min. lengths cannot be shortened

2 Drop seals  
2.1 rebated drop seals for hinged doors

athmer.com



# M-24/20 TS

## 1-248

/ the classic drop seal for aluminum, steel and PVC doors

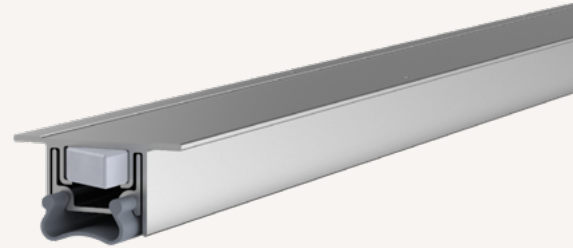

### TECHNICAL DATA

Application	hinged metal & PVC doors
Actuation	single
Gasket material	self-extinguishing silicone

### DIMENSIONS

Width x height	40 x 20 mm
Standard lengths	customized
Minimum lengths*	220 mm
Maximum lengths	2900 mm
Can be shortened by	125 mm, smallest product length that can be shortened: 676 mm
Travel	11 mm

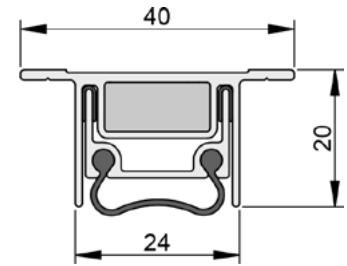

### FIXING/MONTAGE

Fixing	screw fixed into the chamber at the underside of the door
Accessories included with delivery	S008

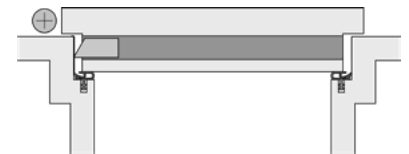

### PERFORMANCE & CERTIFICATES

Fire	UL 10C (R38166)
Acoustic	44dB over 7mm gap, 42dB over 10mm gap

\* min. lengths cannot be shortened



# Schall-Ex® Jumbo I

## 1-154

- / drop seal for extreme under-door gaps
- / covers gaps up to 35mm
- / ideal for listed buildings where maintenance is limited

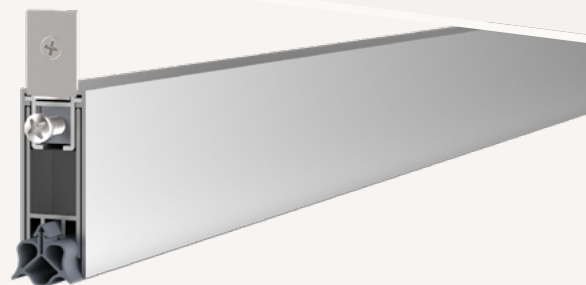

### TECHNICAL DATA

Application	hinged timber & metal door, hinged timber & metal gates
Actuation	single
Gasket material	self-extinguishing silicone

### DIMENSIONS

Width x height	19,5 x 50 mm
Standard lengths	708, 833, 958, 1083, 1208 mm
Minimum lengths*	450 mm
Maximum lengths	1700 mm
Can be shortened by	60 mm from standard lengths
Travel	35 mm

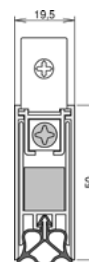

### FIXING/MONTAGE

Fixing	rebated into a groove in the door, screw fixed either side
Accessories included with delivery	5400

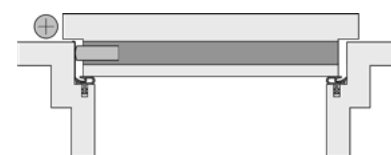

\* min. lengths cannot be shortened

**2 Drop seals**  
2.1 rebated drop seals for hinged doors

athmer.com

Drop seals  
for sliding timber, metal & glass doors

# Smart solutions for space-efficient doors

Our range of sliding door drop seals has been designed with the specific requirements of sliding doors in mind. **Unique design features** like a flat-faced actuator and a low-pressure mechanism are better suited to the door's closing movement, maintaining low door operating forces and supporting long-term durability. There are options for both latched and unlatched sliding doors, with unlatched door options consisting of an integrated magnet for keeping the door closed and sealed. We also supply complete sliding door solutions, including an innovative four-sided seal for comprehensive performance.

The seal drops automatically when the door is closed to **form a seal with the floor**, retracting when the door is opened to ensure the door operation is unhindered. This section covers sliding door solutions for timber, system and glass door leaf materials. Their main purpose is to provide an effective barrier against sound transfer at the door threshold, as well as smoke, air, light, dirt, dust, insects and odours.



## **Drop seals**

for sliding timber, metal & glass doors, and pivot doors

# Schall-Ex® Slide M-12 WS

## 1-548

- / latched sliding door drop seal
- / flat-faced actuator with low activation pressure

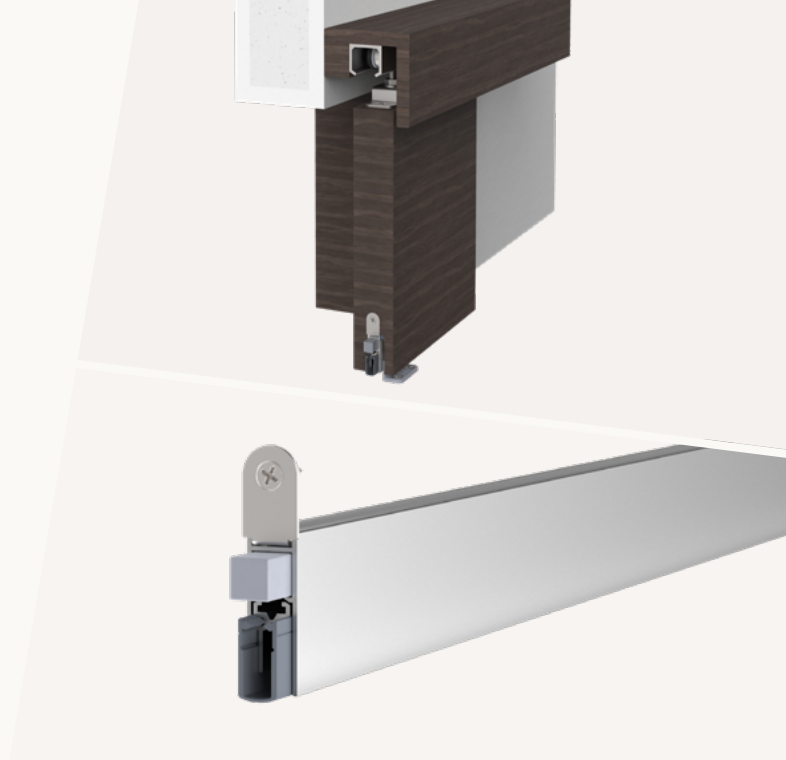

### TECHNICAL DATA

Application	sliding timber doors
Actuation	single
Gasket material	self-extinguishing silicone

### DIMENSIONS

Width x height	12 x 35 mm
Standard lengths	708, 833, 958, 1083, 1208 mm
Minimum lengths*	280 mm
Maximum lengths	1958 mm
Can be shortened by	125 mm from standard lengths
Travel	11 mm

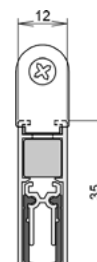

### FIXING/MONTAGE

Fixing	rebated into a groove in the door, screw fixed either side
Accessories included with delivery	5113



### PERFORMANCE & CERTIFICATES

Acoustic	49dB over 7mm gap, 46dB over 10mm gap
----------	---------------------------------------

\* min. lengths cannot be shortened



# Schall-Ex® Slide & Lock M-12 WS

## 1-549

- / unlatched sliding door drop seal
- / flat-faced actuator with low activation pressure
- / integrated magnet for doors without latch or lock



### TECHNICAL DATA

Application	sliding timber doors
Actuation	single
Gasket material	self-extinguishing silicone

### DIMENSIONS

Width x height	12 x 35 mm
Standard lengths	708, 833, 958, 1083, 1208 mm
Minimum lengths*	280 mm
Maximum lengths	1958 mm
Can be shortened by	125 mm from standard lengths
Travel	11 mm

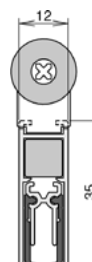

### FIXING/MONTAGE

Fixing	rebated into a groove in the door, screw fixed either side
Accessories included with delivery	5105



### PERFORMANCE & CERTIFICATES

Acoustic	49dB over 7mm gap, 46dB over 10mm gap
----------	---------------------------------------

\* min. lengths cannot be shortened

2 Drop seals  
2.2 drop seals for sliding doors

athmer.com

# Schall-Ex® Slide & Lock L-24/20 WS

**1-965**

/ sliding system door drop seal

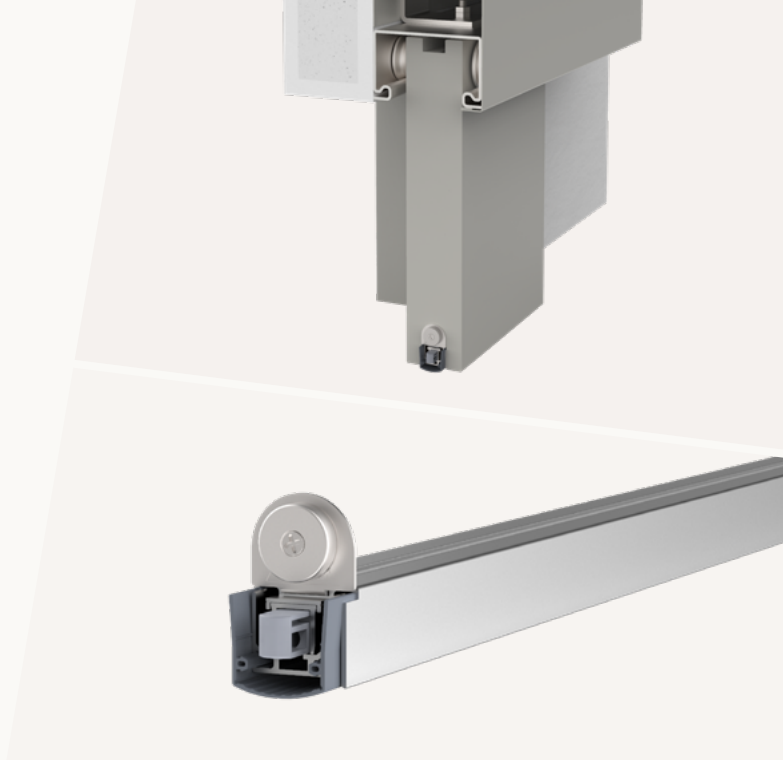

## TECHNICAL DATA

Application	sliding timber & metal & PVC doors
Actuation	single
Gasket material	self-extinguishing silicone

## DIMENSIONS

Width x height	24 x 20 mm
Standard lengths	708, 833, 958, 1083, 1208 mm
Minimum lengths*	485 mm
Maximum lengths	2000 mm
Can be shortened by	150 mm from standard lengths
Travel	16 mm

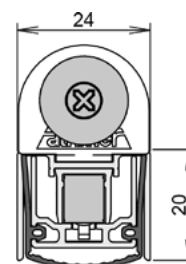

## FIXING/MONTAGE

Fixing	rebated into a groove in the door, screw fixed either side
Accessories included with delivery	5426

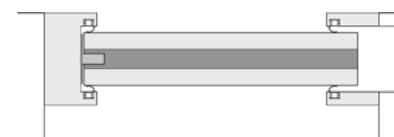

## PERFORMANCE & CERTIFICATES

Acoustic	54dB over 7mm gap, 51dB over 12mm gap
----------	---------------------------------------

\* min. lengths cannot be shortened



# Slide L-15/38 WS

**1-177**

/ latched sliding door drop seal



## TECHNICAL DATA

Application	sliding timber doors
Actuation	single
Gasket material	self-extinguishing silicone

## DIMENSIONS

Width x height	14,8 x 38 mm
Standard lengths	customized
Minimum lengths*	300 mm
Maximum lengths	1700 mm
Can be shortened by	125 mm, smallest product length that can be shortened: 461 mm
Travel	20 mm

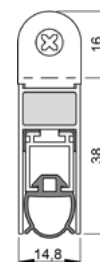

## FIXING/MONTAGE

Fixing	rebated into a groove in the door, screw fixed either side
Accessories included with delivery	S002

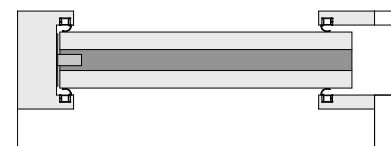

## PERFORMANCE & CERTIFICATES

Fire	EN 1634-1**
Acoustic	43dB over 7mm gap, 42dB over 10mm gap, 39dB over 15mm gap

\* min. lengths cannot be shortened

\*\*The test value may differ according to the EN 1634-1 test, as the complete door system must be checked.

# Slide M-24/20 WS

**1-473**

/ sliding system door drop seal

/ flat-faced actuator

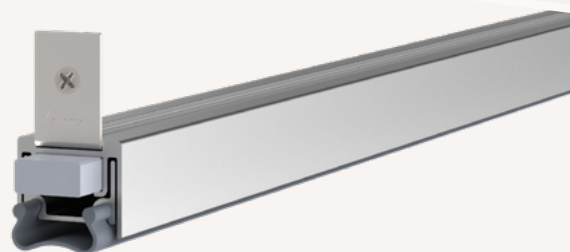

## TECHNICAL DATA

Application	sliding metal doors
Actuation	single
Gasket material	self-extinguishing silicone

## DIMENSIONS

Width x height	24 x 20 mm
Standard lengths	customized
Minimum lengths*	220 mm
Maximum lengths	2000 mm
Can be shortened by	125 mm, smallest product length that can be shortened: 676 mm
Travel	11 mm

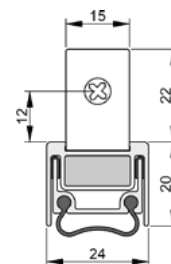

## FIXING/MONTAGE

Fixing	into the chamber at the underside of the door, screw fixed either side
Accessories included with delivery	S007



## PERFORMANCE & CERTIFICATES

Acoustic	44dB over 7mm gap, 42dB over 10mm gap
----------	---------------------------------------

\* min. lengths cannot be shortened

# Slide M-24/21 OS

## 1-471

- / sliding system door drop seal
- / flat-faced actuator



### TECHNICAL DATA

Application	sliding metal doors
Actuation	single
Gasket material	self-extinguishing silicone

### DIMENSIONS

Width x height	24 x 21 mm
Standard lengths	customized
Minimum lengths*	220 mm
Maximum lengths	2900 mm
Can be shortened by	125 mm, smallest product length that can be shortened: 676 mm
Travel	11 mm

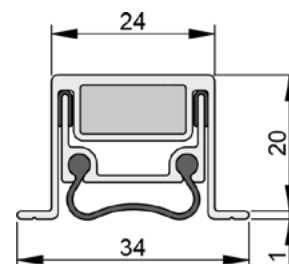

### FIXING/MONTAGE

Fixing	screw fixed into the chamber at the underside of the door
Accessories included with delivery	S008

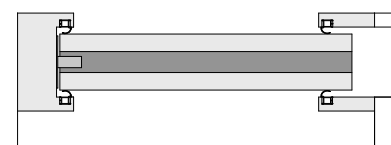

### PERFORMANCE & CERTIFICATES

Acoustic	44dB over 7mm gap, 42dB over 10mm gap
----------	---------------------------------------

\* min. lengths cannot be shortened

# Slide M-24/20 TS

**1-472**

- / sliding system door drop seal
- / flat-faced actuator



## TECHNICAL DATA

Application	sliding metal doors
Actuation	single
Gasket material	self-extinguishing silicone

## DIMENSIONS

Width x height	40 x 20 mm
Standard lengths	customized
Minimum lengths*	220 mm
Maximum lengths	2900 mm
Can be shortened by	125 mm, smallest product length that can be shortened: 676 mm
Travel	11 mm

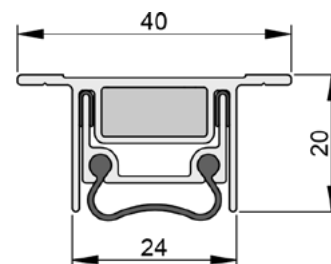

## FIXING/MONTAGE

Fixing	screw fixed into the chamber at the underside of the door
Accessories included with delivery	S008



## PERFORMANCE & CERTIFICATES

Acoustic	44dB over 7mm gap, 42dB over 10mm gap
----------	---------------------------------------

\* min. lengths cannot be shortened

# Schall-Ex® Slide Radiation Protection M-20 WS

**1-557**

/ radiation-resistant drop seal for sliding doors

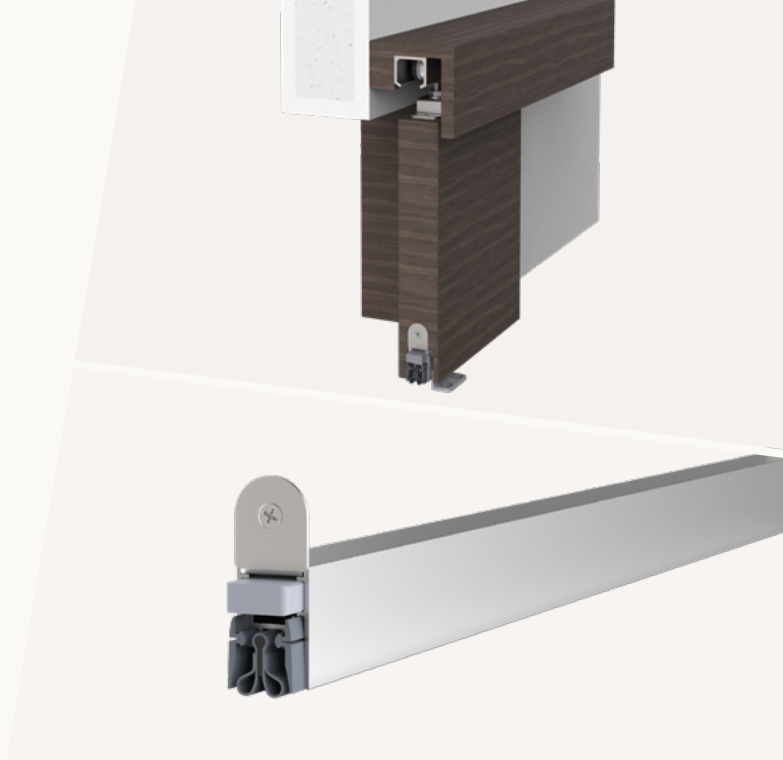

## TECHNICAL DATA

Application	sliding timber doors
Actuation	single
Gasket material	silicone self-extinguishing, lead rubber

## DIMENSIONS

Width x height	19,7 x 30 mm
Standard lengths	708, 833, 958, 1083, 1208 mm
Minimum lengths*	220 mm
Maximum lengths	2000 mm
Can be shortened by	125 mm
Travel	12 mm

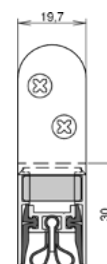

## FIXING/MONTAGE

Fixing	rebated into a groove in the door, screw fixed either side
Accessories included with delivery	5114

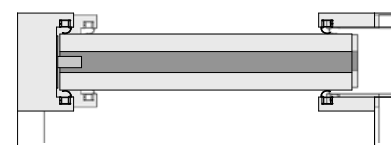

\* min. lengths cannot be shortened

**2 Drop seals**  
2.2 drop seals for sliding doors

athmer.com

# Schall-Ex® Slide Radiation Protection M-20 OS

**1-554**

/ radiation-resistant drop seal for sliding doors

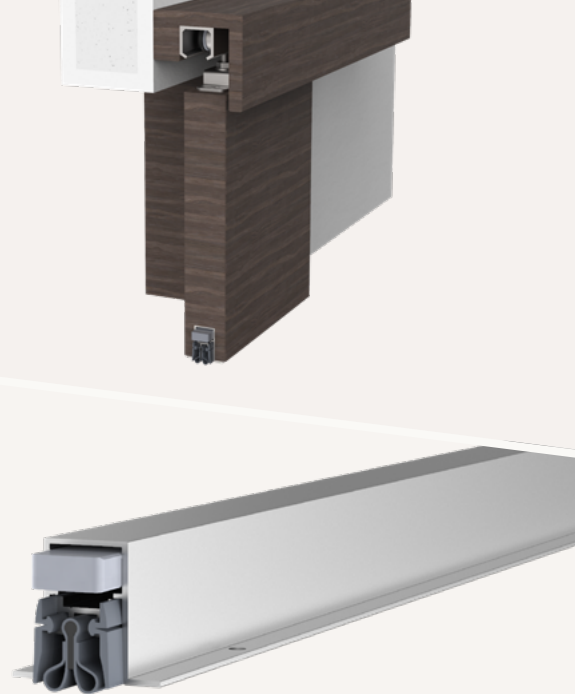

## TECHNICAL DATA

Application	sliding timber doors
Actuation	single
Gasket material	silicone, lead rubber

## DIMENSIONS

Width x height	19,7 x 30 mm
Standard lengths	708, 833, 958, 1083, 1208 mm
Minimum lengths*	220 mm
Maximum lengths	2000 mm
Can be shortened by	125 mm
Travel	12 mm

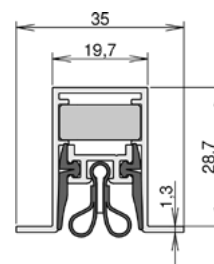

## FIXING/MONTAGE

Fixing	rebated into a groove in the door, screw fixed to the underside
Accessories included with delivery	5111



\* min. lengths cannot be shortened





# Schall-Ex® L-15 Pivot

## 1-946

- / pivot hinge door drop seal
- / suitable with single-acting pivot doors
- / ground-breaking roller actuator suitable for various frame designs



### TECHNICAL DATA

Application	hinged timber doors, doors with pivot hinges
Gasket material	self-extinguishing silicone

### DIMENSIONS

Width x height	15 x 30 mm
Standard lengths	833, 958, 1083, 1208 mm
Minimum lengths*	235 mm
Maximum lengths	2000 mm
Can be shortened by	125 mm from standard lengths
Travel	12 mm

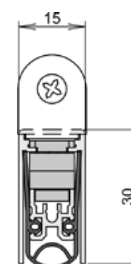

### FIXING/MONTAGE

Fixing	rebated into a groove in the door, screw fixed either side
Accessories included with delivery	5516

### PERFORMANCE & CERTIFICATES

Fire	UL10B & UL10C (R38166)
Acoustic	52dB over 7mm gap
Smoke	Certifire TS21 (CF 5675)

\* min. lengths cannot be shortened

Drop seals  
for hinged glass doors

# Elegant solutions for stylish doors

Our range of drop seals for glass doors has been developed with an **emphasis on the strict aesthetic requirements** demanded by frameless glass construction and with the idea to reduce the seal's visual impact as much as possible. Slimline profiles and clever design traits allow the products to blend seamlessly with the door and its hardware whilst achieving the necessary performance.

The seal drops automatically when the door is closed to form a seal with the floor, retracting when the door is opened to ensure the **door operation is unhindered**. Our range can achieve this with a range of glass thicknesses starting from 6mm. Their main purpose is to provide an effective barrier against sound transfer at the door threshold, as well as smoke, air, light, dirt, dust, insects and odours.



**Drop seals**  
for hinged and sliding glass doors

# Schall-Ex® GS-A

## 1-814 silver-coloured, anod. C-0

- / retrofit glass door drop seal
- / Suitable for new and existing doors with 6mm glass & thicker

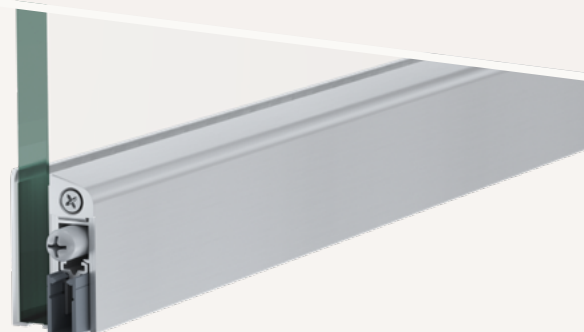

### TECHNICAL DATA

Application	hinged glass doors
Actuation	single
Gasket material	self-extinguishing silicone

### DIMENSIONS

Width x height	15 x 44,5 mm
Standard lengths	708, 833, 958, 1083, 1208 mm
Minimum lengths*	235 mm
Maximum lengths	1333 mm
Can be shortened by	125 mm from standard lengths
Travel	11 mm

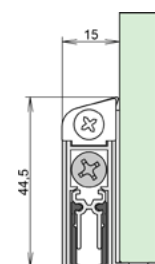

### FIXING/MONTAGE

Fixing	surface-mounted to door, self-adhesive
Accessories included with delivery	5503

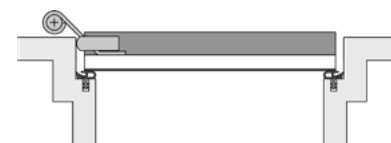

### PERFORMANCE & CERTIFICATES

Acoustic	41dB over 7mm gap, 37dB over 10mm gap
----------	---------------------------------------

### FURTHER VARIANTS

COLORS	ART.NO.
Stainless steel-colored [C-31]	1-815

\* min. lengths cannot be shortened

# Schall-Ex® GS-H10

## 1-453 silver-coloured, anod. C-0

- / architectural glass door drop seal
- / Suitable for new doors with 10mm glass thickness
- / also available with DUO double actuation

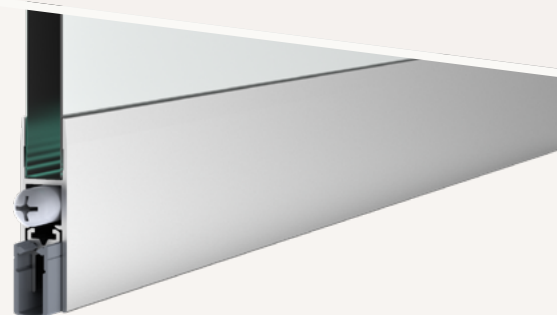

### TECHNICAL DATA

Application	hinged glass doors
Actuation	single
Gasket material	self-extinguishing silicone

### DIMENSIONS

Width x height	12,6 x 32 mm
Standard lengths	708, 833, 958, 1083, 1208 mm
Minimum lengths*	235 mm
Maximum lengths	1333 mm
Can be shortened by	125 mm from standard lengths
Travel	11 mm

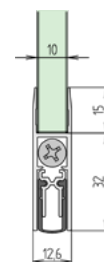

### FIXING/MONTAGE

Fixing	bonded to underside with builder's adhesive (not supplied)
Accessories included with delivery	5503



### PERFORMANCE & CERTIFICATES

Acoustic	40dB over 10mm gap
----------	--------------------

### FURTHER VARIANTS

COLORS/ART.NO.	single actuation	double actuation [techn. data may differ]
Silver-coloured, anod. [C-0]	1-453	1-454
Stainless steel-colored [C-31]	1-677	1-676

\* min. lengths cannot be shortened

2 Drop seals  
2.4 drop seals for hinged glass doors

athmer.com

# Schall-Ex® GS-H8/12

**1-817 silver-coloured, anod. C-0**

- / architectural glass door drop seal
- / Suitable for new doors with glass between 8-12mm thick

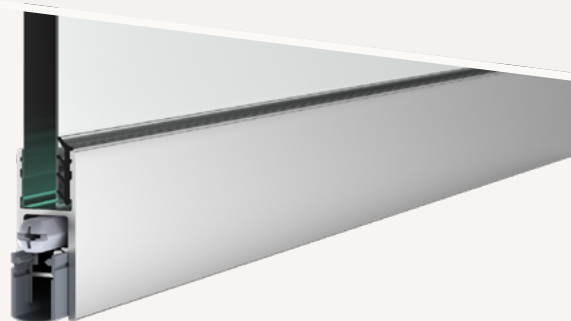

## TECHNICAL DATA

Application	hinged glass doors
Actuation	single
Gasket material	self-extinguishing silicone

## DIMENSIONS

Width x height	16,6 x 27,3 mm
Standard lengths	708, 833, 958, 1083, 1208 mm
Minimum lengths*	235 mm
Maximum lengths	1333 mm
Can be shortened by	125 mm from standard lengths
Travel	12 mm

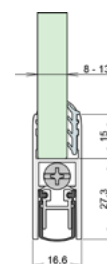

## FIXING/MONTAGE

Fixing	bonded to underside with builder's adhesive (not supplied)
Accessories included with delivery	5550



## PERFORMANCE & CERTIFICATES

Acoustic	40dB over 10mm gap
----------	--------------------

## FURTHER VARIANTS

COLORS	ART.NO.
Stainless steel-colored [C-31]	1-818

\* min. lengths cannot be shortened





# Schall-Ex® Slide GS-A

## 1-875 silver-coloured, anod. C-0

- / retrofit sliding glass door drop seal
- / Suitable for new and existing doors with 6mm glass & thicker
- / flat-faced actuator with low activation pressure

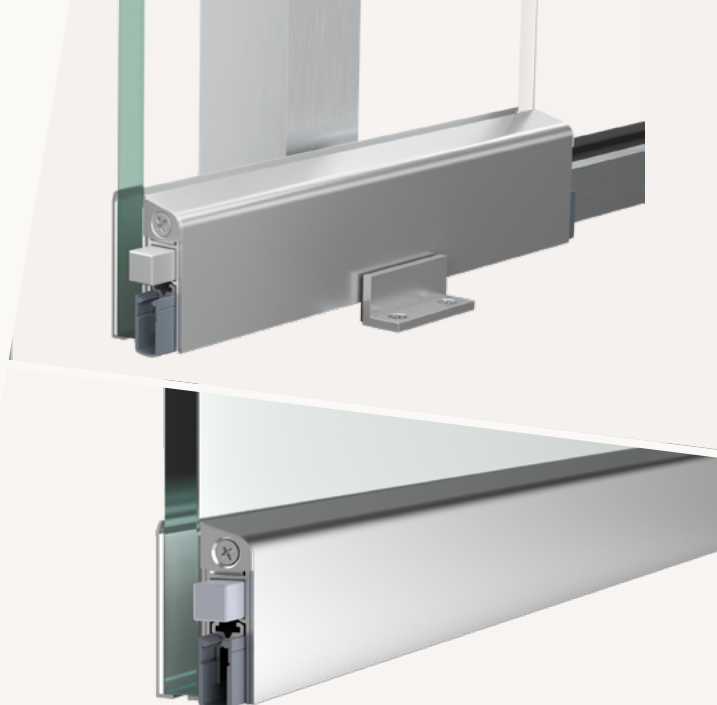

### TECHNICAL DATA

Application	sliding glass doors
Actuation	single
Gasket material	self-extinguishing silicone

### DIMENSIONS

Width x height	15,4 x 45 mm
Standard lengths	708, 833, 958, 1083, 1208 mm
Minimum lengths*	235 mm
Maximum lengths	1958 mm
Can be shortened by	125 mm from standard lengths
Travel/Hub	11 mm

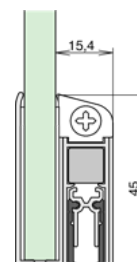

### FIXING/MONTAGE

Fixing	surface-mounted to door, self-adhesive
Accessories included with delivery	5115



### PERFORMANCE & CERTIFICATES

Acoustic	41dB over 7mm gap, 37dB over 10mm gap
----------	---------------------------------------

### FURTHER VARIANTS

COLORS	ART.NO.
Stainless steel-colored [C-31]	1-876

\* min. lengths cannot be shortened

# Schall-Ex® Slide GS-H10

## 1-572 silver-coloured, anod. C-0

- / architectural sliding glass door drop seal
- / Suitable for new doors with 10mm glass thickness
- / flat-faced actuator with low activation pressure



### TECHNICAL DATA

Application	sliding glass doors
Actuation	single
Gasket material	self-extinguishing silicone

### DIMENSIONS

Width x height	12,6 x 32 mm
Standard lengths	708, 833, 958, 1083, 1208 mm
Minimum lengths*	280 mm
Maximum lengths	1605 mm
Can be shortened by	125 mm from standard lengths
Travel/Hub	11 mm

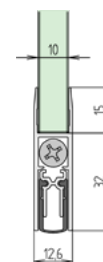

### FIXING/MONTAGE

Fixing	bonded to underside with builder's adhesive (not supplied)
Accessories included with delivery	5115



### PERFORMANCE & CERTIFICATES

Acoustic	40dB over 10mm gap
----------	--------------------

### FURTHER VARIANTS

COLORS	ART.NO.
Stainless steel-colored (C-31)	1-681

\* min. lengths cannot be shortened

2 Drop seals  
2.5 drop seals for sliding glass doors

athmer.com

Surface mounted drop seals  
for hinged timber & metal doors

# Retrofit solutions for existing doors

Our range of surface mounted drop seals have been designed for use with existing doors that have been subjected to **new performance requirements**. Slimline, stylish design and concealed fixing points help maintain the door aesthetic where fully concealed drop seals cannot be fitted. For instances where time is a factor, clever installation features accommodate quick and easy installation.

The **seal drops automatically** when the door is closed to form a seal with the floor, retracting when the door is opened to ensure the door operation is unhindered. Their main purpose is to provide an effective barrier against sound transfer at the door threshold, as well as smoke, air, light, dirt, dust, insects and odours.





**Surface mounted drop seals**  
for hinged timber & metal doors



# M-12 FS

1-747

- / surface-mounted drop seal
- / concealed screws and slide-on cover profile

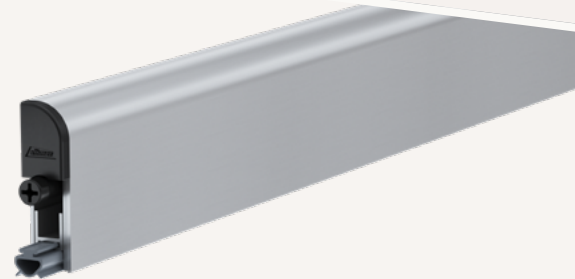

## TECHNICAL DATA

Application	hinged timber & metal doors
Actuation	single
Gasket material, color	silicone, grey

## DIMENSIONS

Width x height	13 x 49 mm
Standard lengths	customized
Minimum lengths*	320 mm
Maximum lengths	1200 mm
Can be shortened by	125 mm, smallest product length that can be shortened: 445 mm
Travel	15 mm

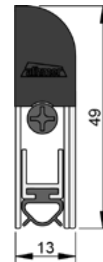

## FIXING/MONTAGE

Fixing	surface mounted to the face of the door, screw fixed
Accessories included with delivery	S012

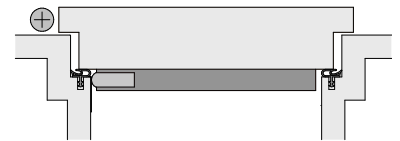

## PERFORMANCE & CERTIFICATES

Fire	UL 10B & 10C
Acoustic	STC 36

## FURTHER VARIANTS

	ART.NO.
TPE, no UL,	1-742
TPE, no UL, black cover & gasket	1-743

\* min. lengths cannot be shortened



# Wind Ex S

## 1-1024

- / self-levelling mechanism
- / removable actuator deactivates automatic function during the construction phase
- / seal can be easily adjusted by hand

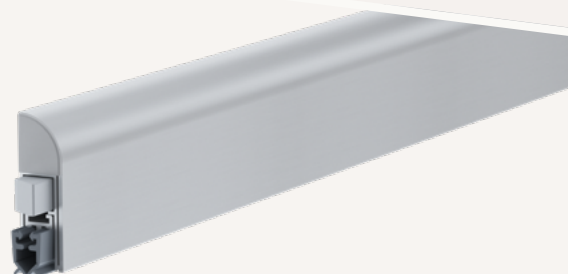

### TECHNICAL DATA

Application	hinged timber doors
Actuation	single
Gasket material	self-extinguishing silicone

### DIMENSIONS

Width x height	13,5 x 44 mm
Standard lengths	735, 860, 985, 1110 mm
Minimum lengths*	235 mm
Maximum lengths	1330 mm
Can be shortened by	125 mm
Travel	11 mm

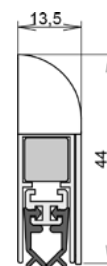

### FIXING/MONTAGE

Fixing	rebated into a groove in the door, screw fixed either side
Accessories included with delivery	

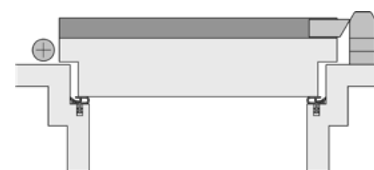

\* min. lengths cannot be shortened

# Schall-Ex® Applic A

**1-658 silver-coloured, anod. C-0**

/ click-in cover profile

/ concealed screws

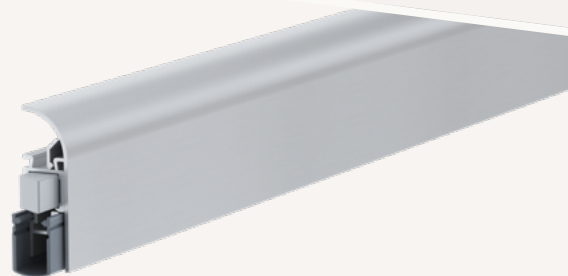

## TECHNICAL DATA

Application	hinged timber & PVC doors
Actuation	single
Gasket material	self-extinguishing silicone

## DIMENSIONS

Width x height	14,5 x 46 mm
Standard lengths	805, 930, 1055 mm
Minimum lengths*	235 mm
Maximum lengths	1333 mm
Can be shortened by	125 mm
Travel	11 mm

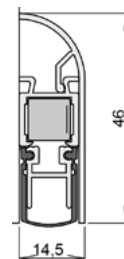

## FIXING/MONTAGE

Fixing	surface mounted to the face of the door, screw fixed
Accessories included with delivery	5126

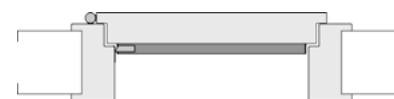

## FURTHER VARIANTS

COLORS	ART.NO.
White (RAL 9016)	1-668
Dark brone anod. (C-31)	1-669

\* min. lengths cannot be shortened



# Schall-Ex® L-15 FS

**1-884 silver-coloured, anod. C-0**

- / surface-mounted drop seal
- / parallel drop minimises friction with the floor
- / tool-free actuator can be deactivated before building occupancy
- / actuator requires no protective press plate for the frame
- / no lateral travel during actuation enhances gasket position

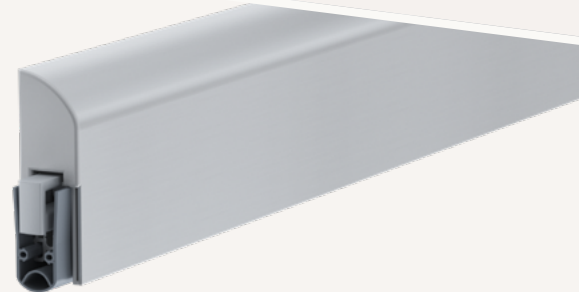

## TECHNICAL DATA

Application	hinged timber & metal & PVC doors
Actuation	single
Gasket material	self-extinguishing silicone

## DIMENSIONS

Width x height	17,2 x 54 mm
Standard lengths	805, 930, 1055 mm
Minimum lengths*	235 mm
Maximum lengths	1600 mm
Can be shortened by	125 mm from standard lengths
Travel	20 mm

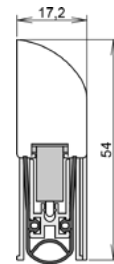

## FIXING/MONTAGE

Fixing	surface mounted to the face of the door, screw fixed
Accessories included with delivery	5314

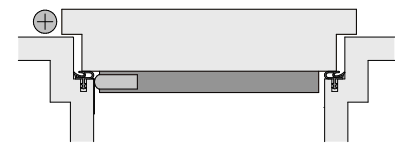

## PERFORMANCE & CERTIFICATES

Fire	EN 1634-1**, UL 10B & 10C (R38166)
Acoustic	52dB over 7mm gap, 51dB over 12mm gap
Smoke	Certifire TS21 (CF 5675)

## FURTHER VARIANTS

COLORS	ART.NO.
Stainless steel-colored [C-31]	1-885
White [RAL 9016]	1-888

\* min. lengths cannot be shortened

\*\*The test value may differ according to the EN 1634-1 test, as the complete door system must be checked.

2 Drop seals  
2.6 surface mounted drop seals

athmer.com

# Schall-Ex® Jumbo II

## 1-474

- / surface-mounted drop seal for extreme under-door gaps
- / covers gaps up to 50mm
- / ideal for listed buildings where maintenance is limited
- / robust stainless steel cover plate

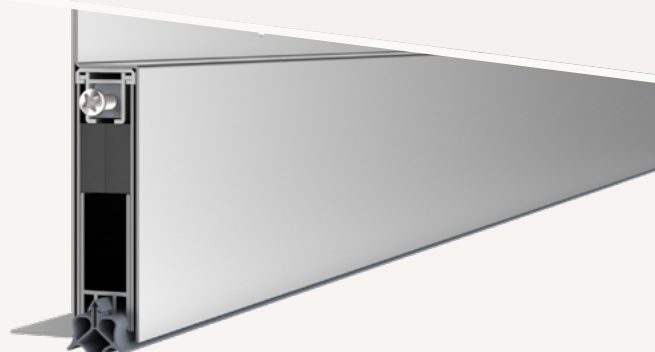

### TECHNICAL DATA

Application	hinged timber & metal doors, hinged timber & metal gates
Actuation	single
Gasket material	self-extinguishing silicone

### DIMENSIONS

Width x height	22 x 81 mm
Standard lengths	708, 833, 958, 1083, 1208 mm
Minimum lengths*	710 mm
Maximum lengths	1700 mm
Can be shortened by	60 mm from standard lengths
Travel	50 mm

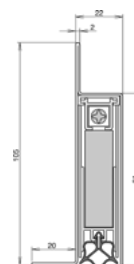

### FIXING/MONTAGE

Fixing	surface mounted to the face of the door, screw fixed
Accessories included with delivery	5935

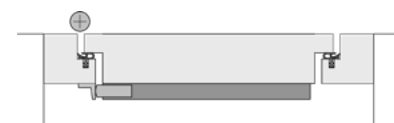

\* min. lengths cannot be shortened

# Schall-Ex® Jumbo III

## 1-157

- / surface-mounted drop seal for extreme under-door gaps
- / covers gaps up to 35mm
- / ideal for listed buildings where maintenance is limited
- / robust stainless steel cover plate

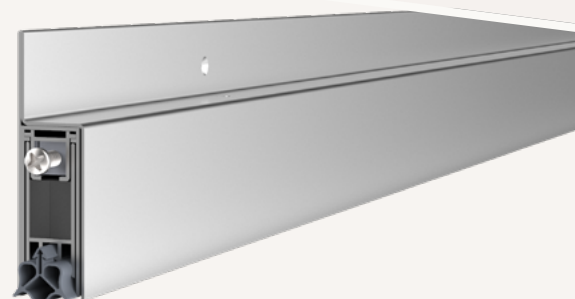

### TECHNICAL DATA

Application	hinged timber & metal doors, hinged timber & metal gates
Actuation	single
Gasket material	self-extinguishing silicone

### DIMENSIONS

Width x height	22 x 52,5 mm
Standard lengths	708, 833, 958, 1083, 1208 mm
Minimum lengths*	450 mm
Maximum lengths	1700 mm
Can be shortened by	60 mm from standard lengths
Travel	35 mm

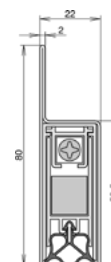

### FIXING/MONTAGE

Fixing	surface mounted to the face of the door, screw fixed
Accessories included with delivery	5935

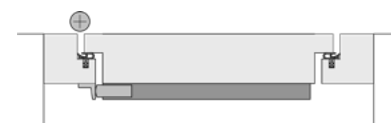

\* min. lengths cannot be shortened

2 Drop seals  
2.6 surface mounted drop seals

athmer.com

## Flush bolt

- / integrated flush bolt
- / continuous seal around bolt maintains optimal acoustic performance
- / machining of seal prepared by athmer before delivery
- / matching top and bottom versions available with same milling dimensions
- / compatible with Schall-Ex® L-15, Schall-Ex® Ultra and Stadi models



### DIMENSIONS

	for timber doors	for metal doors
Fitting tolerance range	8mm diameter bolt. 15mm throw, max. 10mm gap	
TK-15/T	250 mm	250 mm
TK-20/B-SU	266 mm	-
TK-15/BXL	276 mm	-
TK-20 II	-	274 mm

### TECHNICAL DATA

Application	hinged doors
Material	stainless steel
Fixing	rebated into a groove in the door, screw fixed

### ART.NO.

TK-15/T	1653
TK-20/B-SU	1652-2
TK-15/BXL	1792
TK-20 II	1651

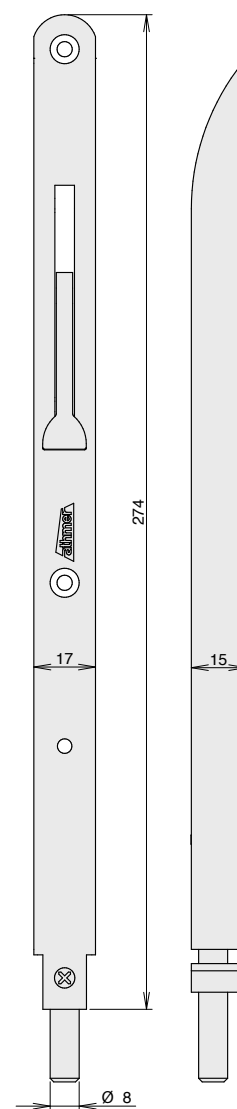



## Concealed flush bolt

- / integrated concealed flush bolt
- / continuous seal around bolt maintains optimal acoustic performance
- / machining of seal prepared by athmer before delivery
- / fully concealed unit, ideal for automatic & panic systems
- / M6 & M10 bolt connection options
- / compatible with Schall-Ex® L-15, Schall-Ex® Ultra and Stadi models



### DIMENSIONS/ART.NO. for timber doors for metal doors

Fitting tolerance range 8mm diameter bolt. 15mm throw, max. 10mm gap

1502-1187 M6, 1,187 mm M6, 1,187 mm

1502-1217 M10, 1,217 mm M10, 1,217 mm

1502-1487 M6, 1,487 mm M6, 1,487 mm

1502-1517 M10, 1,517 mm M10, 1,517 mm

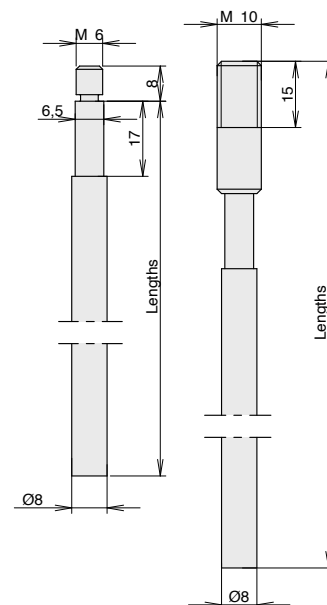

### TECHNICAL DATA

Application	hinged doors
Material	stainless steel
Fixing	rebated into a groove in the door, screw fixed

## Bottom seals

# Effective containment

Our range of bottom seals are a permanent solution and ideal for sealing the gap between door and bottom. They can be both surfaced mounted and rebated into a groove with screws. Use with one of our threshold plate for the **optimum sealing** solution.

Bottom seals effectively seal the gap against sound, dust, light and vermin. Special seals also provide **smoke protection**.

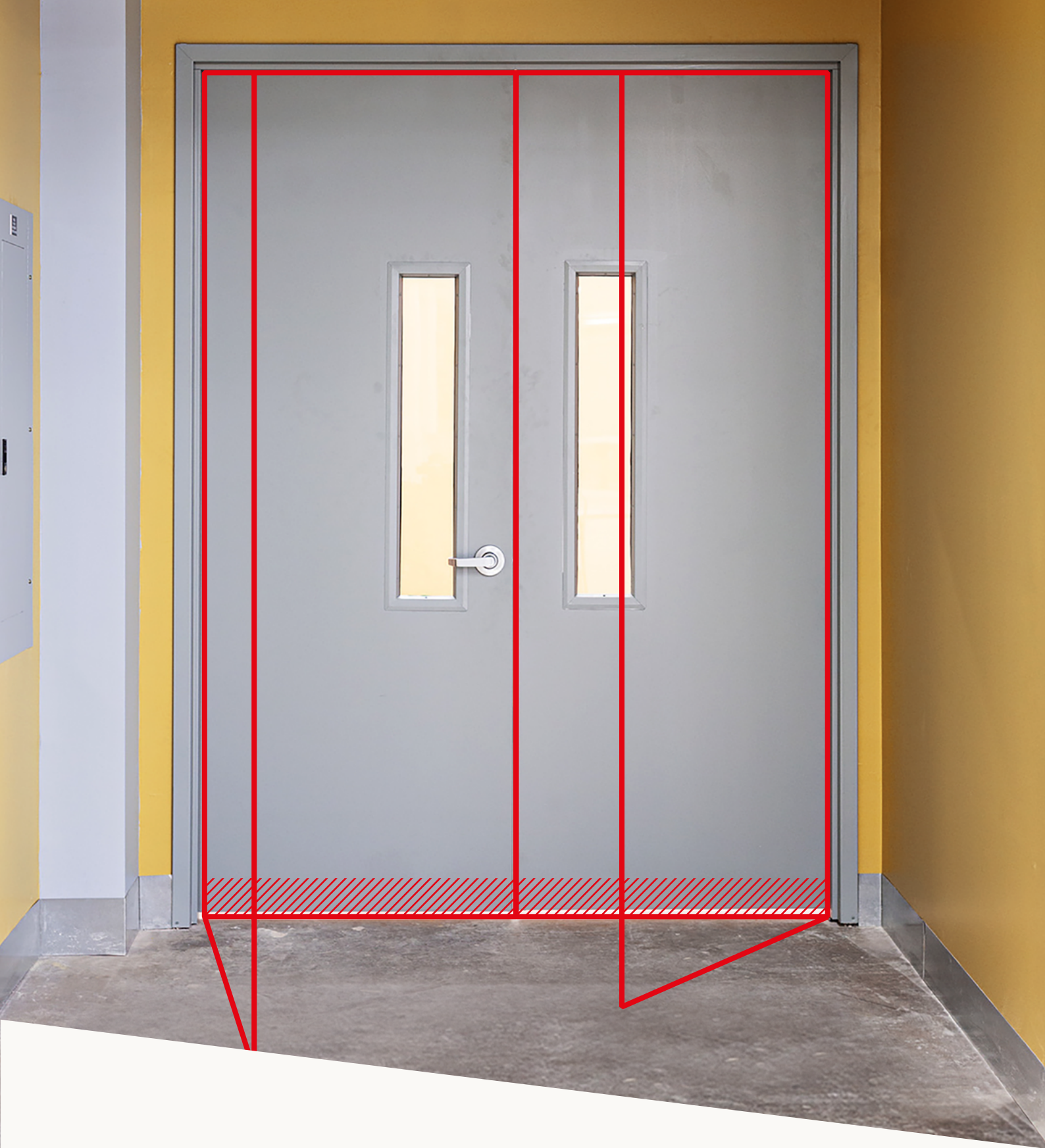

**Bottom seals**



# BS 3515 S

/ door shoe seal for applications where drop seals cannot be used

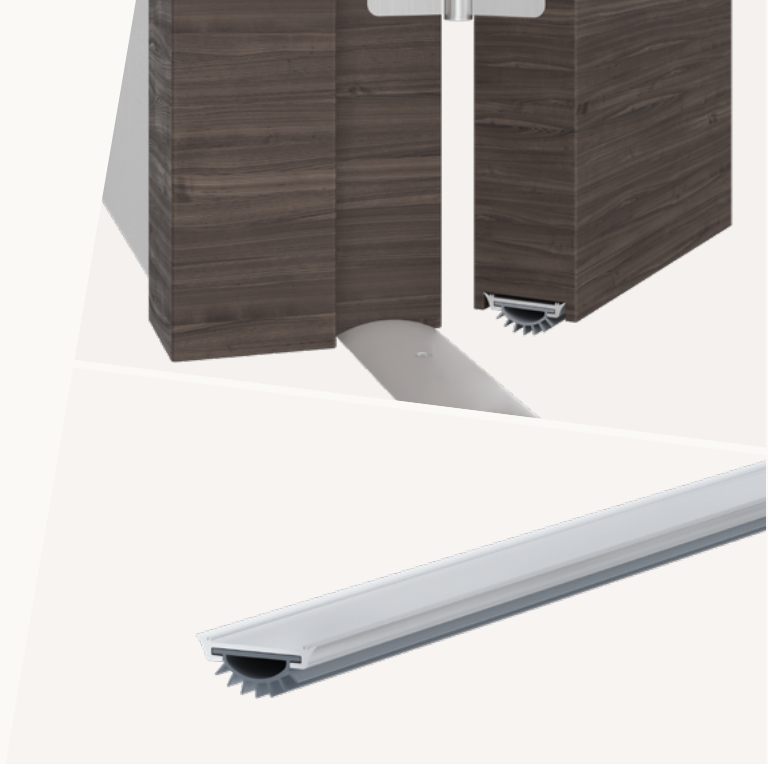

### TECHNICAL DATA

Application	at the threshold of hinged, single and double action doors
Gasket material	PVC
Carrier material	aluminum, anodized

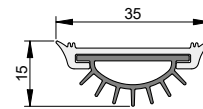

### DIMENSIONS

Width x height	35 x 15 mm
Bottom gap size	[morticed] 6 - 7.5 mm, [surface mounted] 13 - 14.5 mm
Standard lengths	1.000, 1.500, 3.000 mm
Maximum lengths	3.000 mm
Can be shortened by	any length

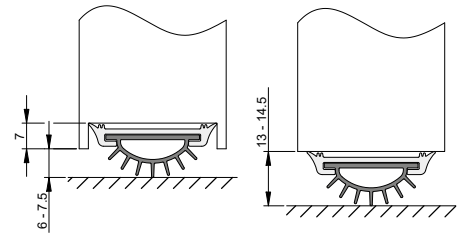

### FIXING

Fixing	screw fixed to the underside of the door
--------	--

### PERFORMANCE & CERTIFICATES

UL	UL 10C (R38166)
----	-----------------

### COLORS [carrier, gasket]

Silver anodized, grey	<b>ART.NO.</b> P160094
-----------------------	---------------------------

# BS 3017 V

/ triple fin door shoe seal

/ for applications where drop seals cannot be used

## TECHNICAL DATA

Application	at the threshold of hinged, single and double action doors
Gasket material	PVC
Carrier material	aluminum, anodized

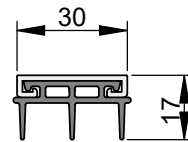

## DIMENSIONS

Width x height	30 x 17 mm
Bottom gap size	morticed: 8.5 - 10 mm, surface mounted: 15.5 - 17 mm
Standard lengths	1.000, 2.250, 2.500, 3.000 mm
Maximum lengths	3.000 mm
Can be shortened by	any length

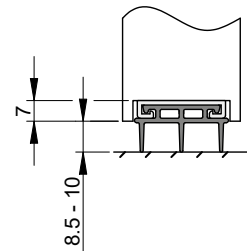

## FIXING

Fixing	screw fixed to the underside of the door
--------	--

**COLORS** [carrier, gasket]

Silver anodized, black

**ART.NO.**

P160196



# BS 4006 S

- / versatile fin seal in a slim design
- / suitable for medium temperature smoke, draught, dust, and weather protection
- / covering gaps up to 20mm
- / with elongated fixing holes for easy positioning and adjustment
- / fixing screws concealed by snap on cover
- / works in combination with almost any threshold plate

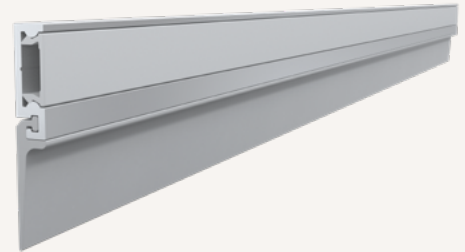

## TECHNICAL DATA

Application	single and double swing, revolving, tilt-up and roller doors
Gasket material	self-extinguishing silicone
Carrier material	aluminum, anodized

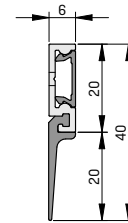

## DIMENSIONS

Width x height	6 x 40 mm
Bottom gap size	1 - 20 mm
Standard lengths	1.000, 2.100, 2.250, 2.500, 3.000 mm
Maximum lengths	3.000 mm
Can be shortened by	any length

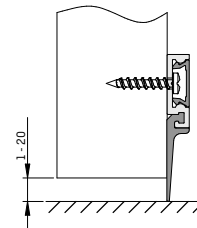

## FIXING

Fixing	surface mounted to the face of the door, screw fixed
--------	--

## PERFORMANCE & CERTIFICATES

UL	UL 10C (R38166)
----	-----------------

COLORS (carrier, gasket)	ART.NO.	ACCESSORIES (incl. in delivery)
Silver anodized, grey	1-750	S019
Black anodized, black	1-751	S019





# BS 4807 S

- / versatile fin seal in a slim design
- / suitable for medium temperature smoke, draught, dust, and weather protection
- / covering gaps up to 20mm
- / with elongated fixing holes for easy positioning and adjustment
- / fixing screws concealed by snap on cover
- / works in combination with almost any threshold plate

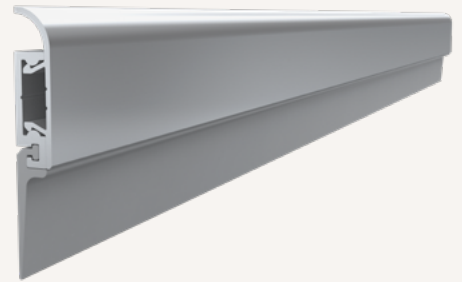

## TECHNICAL DATA

Application	single and double swing, revolving, tilt-up and roller doors
Gasket material	self-extinguishing silicone
Carrier material	aluminum, anodized

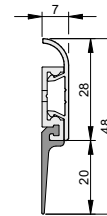

## DIMENSIONS

Width x height	7 x 48 mm
Bottom gap size	1 - 20 mm
Standard lengths	1.000, 2.100, 2.250, 2.500, 3.000 mm
Maximum lengths	3.000 mm
Can be shortened by	any length

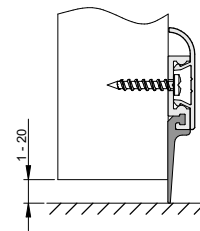

## FIXING

Fixing	surface mounted to the face of the door, screw fixed
--------	--

## PERFORMANCE & CERTIFICATES

UL	UL 10C (R38166)
----	-----------------

COLORS (carrier, gasket)	ART.NO.	ACCESSORIES (incl. in delivery)
Silver anodized, grey	1-752	S019
Black anodized, black	1-753	S019



# BS 5114 S

- / dual-purpose rain drip guard with gasket for protecting door thresholds from dripping water & draughts
- / suitable for medium temperature smoke, draught, dust, and weather protection
- / works in combination with almost any threshold plate

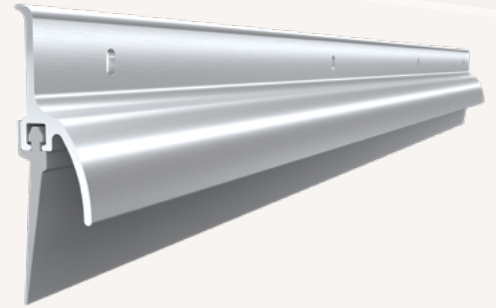

### TECHNICAL DATA

Application	at the threshold of external doors
Gasket material	vinyl PVC
Carrier material	aluminum, anodized

### DIMENSIONS

Width x height	14 x 51 mm
Bottom gap size	1 - 14 mm
Standard lengths	1.000, 2.250, 2.500, 3.000 mm
Maximum lengths	3.000 mm
Can be shortened by	any length

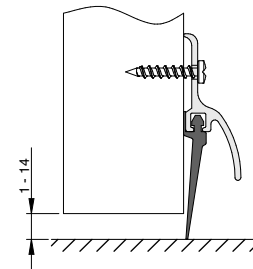
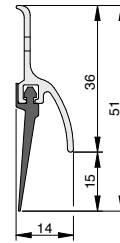

### FIXING

Fixing	surface mounted to the face of the door, screw fixed
--------	--

### PERFORMANCE & CERTIFICATES

UL	UL 10C [R38166]
----	-----------------

### COLORS [carrier, gasket]

Silver anodized, grey	ART.NO. P160100
-----------------------	--------------------

# BS 2906 P

- / triple fin bottom seal in a slim design
- / suitable for medium temperature smoke, draught, dust, and weather protection
- / with elongated fixing holes for easy positioning and adjustment
- / fixing screws concealed by snap on cover
- / works in combination with almost any threshold plate

## TECHNICAL DATA

Application	single and double swing, revolving, tilt-up and roller doors
Gasket material	PVC
Carrier material	aluminum, anodized

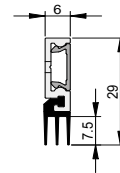

## DIMENSIONS

Width x height	6 x 29 mm
Bottom gap size	1 - 5 mm
Standard lengths	1.000, 2.100, 2.250, 2.500, 3.000 mm
Maximum lengths	3.000 mm
Can be shortened by	any length

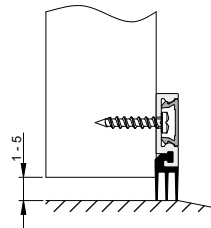

## FIXING

Fixing	surface mounted to the face of the door, screw fixed
--------	--

COLORS (carrier, gasket)	ART.NO.	ACCESSORIES (incl. in delivery)
Silver anodized, black	1-1079	S019



# BR 4911

- / versatile brush strip for use in a variety of draft-proofing applications
- / fixing screws concealed by snap on cover

## TECHNICAL DATA

Application	at the threshold of hinged, single action doors and around the perimeter of sliding doors
Brush material	Nylon
Carrier material	aluminum, anodized

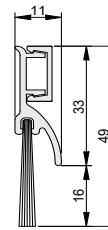

## DIMENSIONS

Width x height	11 x 49 mm
Standard lengths	1.000, 2.250, 2.500, 3.000 mm
Maximum lengths	3.000 mm
Can be shortened by	any length

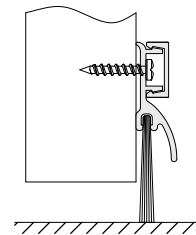

## FIXING

Fixing	surface mounted to the face of the door, screw fixed
--------	--

## PERFORMANCE & CERTIFICATES

UL	UL 10C (R38166)
----	-----------------

## COLORS (carrier, brush)

Silver anodized, black

## ART.NO.

P160202



# BR 3506

/ versatile brush strip for use in a variety of draft-proofing applications

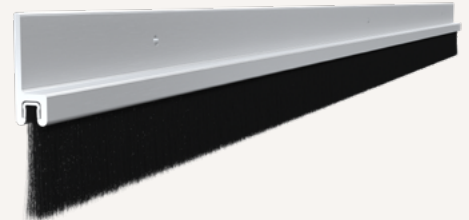

## TECHNICAL DATA

Application	at the threshold of hinged, single action doors and around the perimeter of sliding doors
Brush material	PP
Carrier material	aluminum, anodized

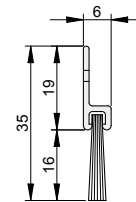

## DIMENSIONS

Width x height	6 x 35 mm
Bottom gap size	11 - 15 mm
Standard lengths	1.000, 2.100, 2.400, 3.000 mm
Maximum lengths	3.000 mm
Can be shortened by	any length

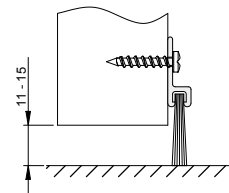

## FIXING

Fixing	surface mounted to the face of the door, screw fixed
--------	--

## PERFORMANCE & CERTIFICATES

UL	UL 10C [R38166]
----	-----------------

## COLORS (carrier, brush)

Silver anodized, grey

## ART.NO.

P160122

Intumescent seals  
& hardware protection

# Essential components for fire doors

Our range of intumescent fire seals is suitable for use in a variety of **fire door applications**. Fire doors help protect lives and property by slowing the spread of fire throughout a building. Intumescent fire seals are a key component in fire doors, used to protect the gaps between the door and frame as well as encasing certain door hardware. Intumescent fire seals help resist fire by expanding during fire conditions to fill gaps and provide a degree of insulation.

The range consists of several intumescent materials including graphite-based, silicate-based and phosphate-based solutions depending on your technical preference. As well as a choice of material, our products can be chosen with or without a protective PVC casing. Our encased intumescent fire seals can be supplied with integrated brushes and fins for additional **smoke and acoustic protection**. Thinner, more flexible intumescent options are available if required.





**Intumescent seals**  
& hardware protection

## F Series

- / flexible graphite fire seal
- / provides fire protection for doors
- / equipped with a durable self-adhesive backing tape
- / supplied in coil form

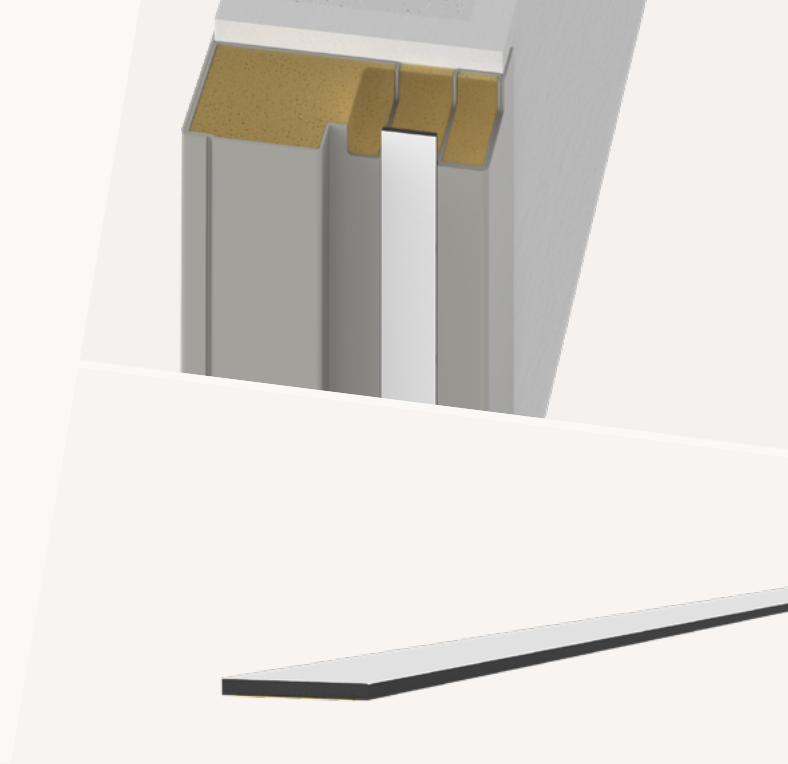

### TECHNICAL DATA

Application	fire rated metal doors & frames
Material	graphite with thin PVC film

### DIMENSIONS

Standard lengths	50 m coil
------------------	-----------

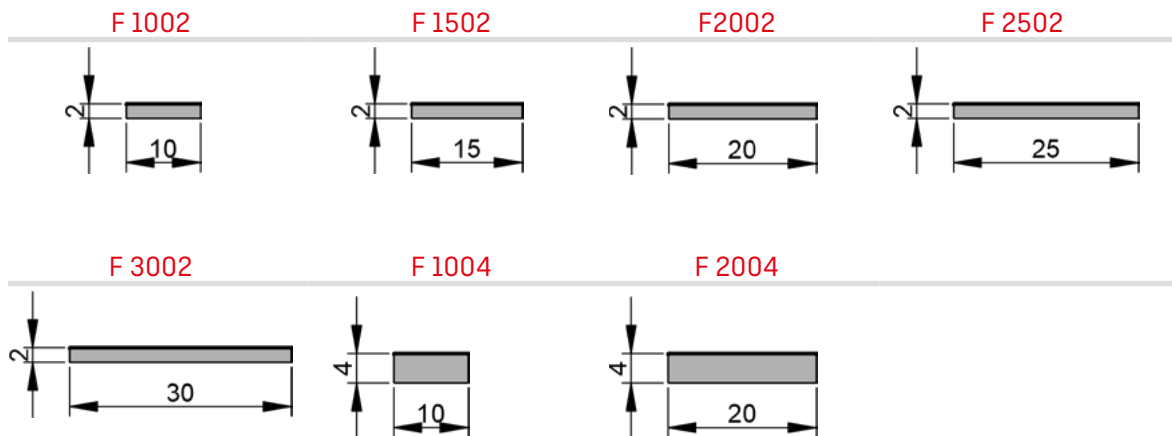

COLORS/ART.NO.	F 1002	F 1502	F 2002	F 2502	F 3002	F 1004	F 2004
Red	F160091	F160088	F160085	F160098	F160102	-	-
Black	F160116	F160117	F160118	F160119	F160120	-	-
Brown	F160092	F160089	F160086	F160099	F160103	-	-
White	F160093	F160090	F160087	F160100	F160104	-	-
Natural graphite grey	F160095	F160096	F160097	F160101	F160105	F160121	F160122

# FB Series

- / rigid box graphite fire & smoke seal with brush
- / provides fire and smoke protection for doors
- / equipped with a durable self-adhesive backing tape
- / supplied in lengths



## TECHNICAL DATA

Application	fire rated timber doors & frames
Material	PVC encapsulated graphite, with a PP brush

## PERFORMANCE & CERTIFICATES

Fire	EN 1634-1*, Certifire TS35 [CF 6057]
Smoke	Certifire TS21 [CF 6057]

## DIMENSIONS

Standard lengths	2100, 2400, 3000 mm
------------------	---------------------

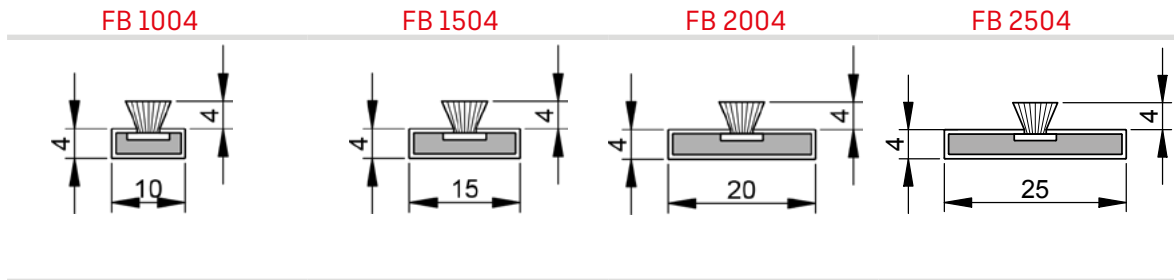

COLORS/ART.NO.	FB 1004	FB 1504	FB 2004	FB 2504
Red	F160067	F160070	F160073	F160243
Black	F160110	F160111	F160112	F160239
Dark brown	F160068	F160071	F160074	F160238
Brown	F160228	F160231	F160234	F160237
White	F160069	F160072	F160075	F160240
Grey	F160069	F160232	F160235	F160241
Cream	F160230	F160233	F160236	F160242

\*The test value may differ according to the EN 1634-1 test, as the complete door system must be checked.

# FP Series

- / plain, rigid box graphite fire seal
- / provides fire protection for doors
- / equipped with a durable self-adhesive backing tape
- / supplied in lengths

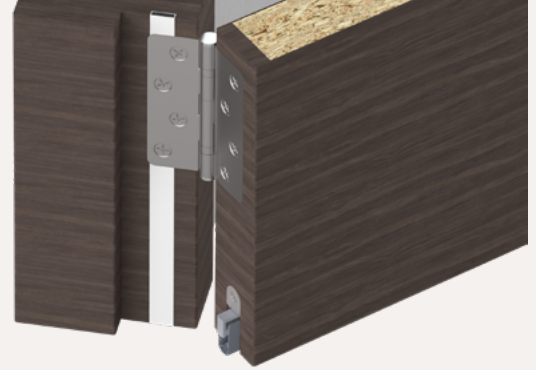

## TECHNICAL DATA

Application	fire rated timber doors & frames
Material	PVC encapsulated graphite

## PERFORMANCE & CERTIFICATES

Fire	EN 1634-1*, Certifire TS35 [CF 6057]
Smoke	Certifire TS21 [CF 6057]

## DIMENSIONS

Standard lengths	2100, 2400, 3000 mm
------------------	---------------------

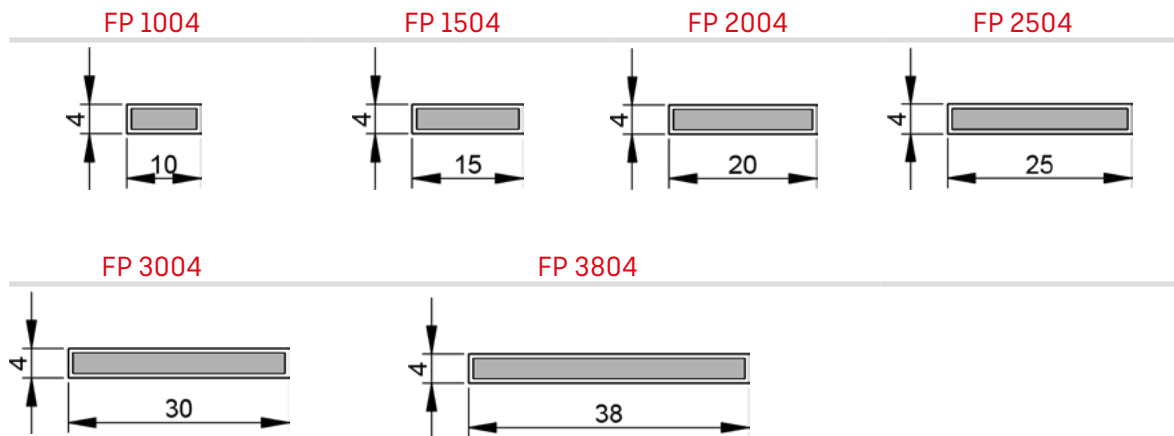

COLORS/ART.NO.	FP 1004	FP 1504	FP 2004	FP 2504	FP 3004	FP 3804
Red	F160052	F160055	F160058	F160150	F160061	F160064
Black	F160105	F160106	F160107	F160153	F160109	F160108
Dark brown	F160053	F160056	F160059	F160151	F160062	F160065
Brown	F160218	F160220	F160222	F160225	F160062	F160065
White	F160054	F160057	F160060	F160152	F160063	F160066
Grey	F160215	F160216	F160223	F160226		
Cream	F160219	F160122	F160224	F160227		

\*The test value may differ according to the EN 1634-1 test, as the complete door system must be checked.



5 Intumescent seals & hardware protection  
5.1 graphite intumescent seals

athmer.com



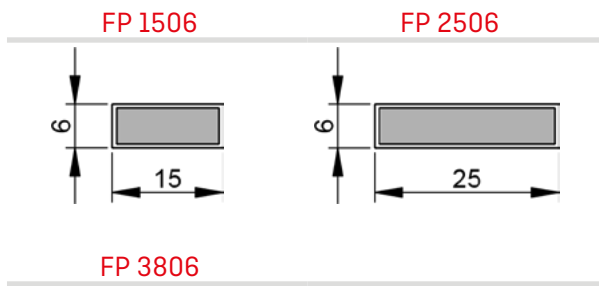

COLORS/ART.NO.	FP 1506	FP 2506
Black	F160201	F160199
Dark brown	F160125	F160127
Brown	F160289	F160297
White	F160200	F160198

# FF-C Series

- / rigid box graphite fire & smoke seal with double central fin
- / provides fire, smoke and acoustic protection for doors
- / equipped with a durable self-adhesive backing tape
- / supplied in lengths

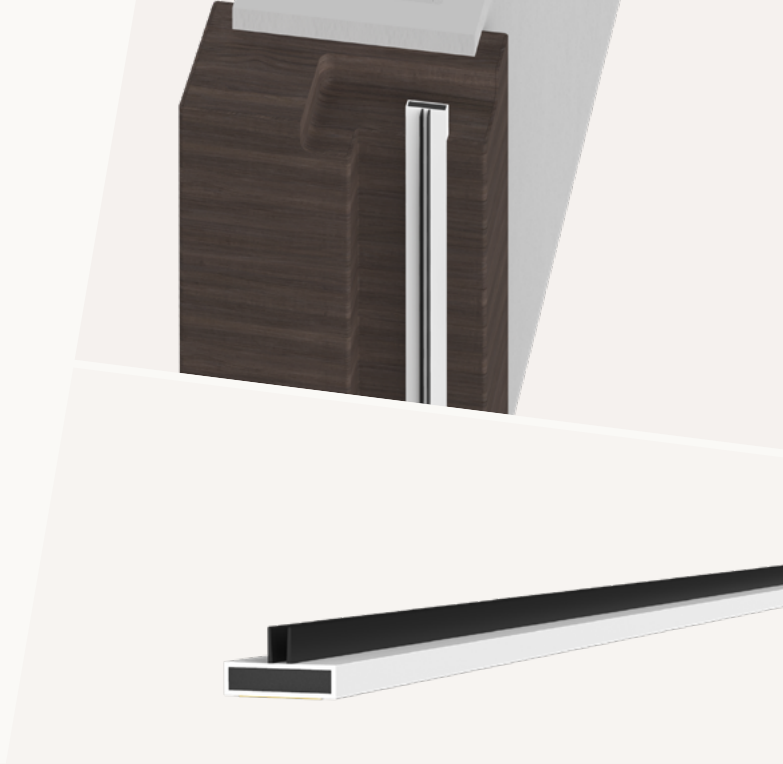

## TECHNICAL DATA

Application	fire rated timber doors & frames
Material	PVC encapsulated graphite, with soft PVC fins

## PERFORMANCE & CERTIFICATES

Fire	EN 1634-1*, Certifire TS35 [CF 6057]
Smoke	Certifire TS21 [CF 6057]

## DIMENSIONS

Standard lengths	2100, 2400, 3000 mm
------------------	---------------------

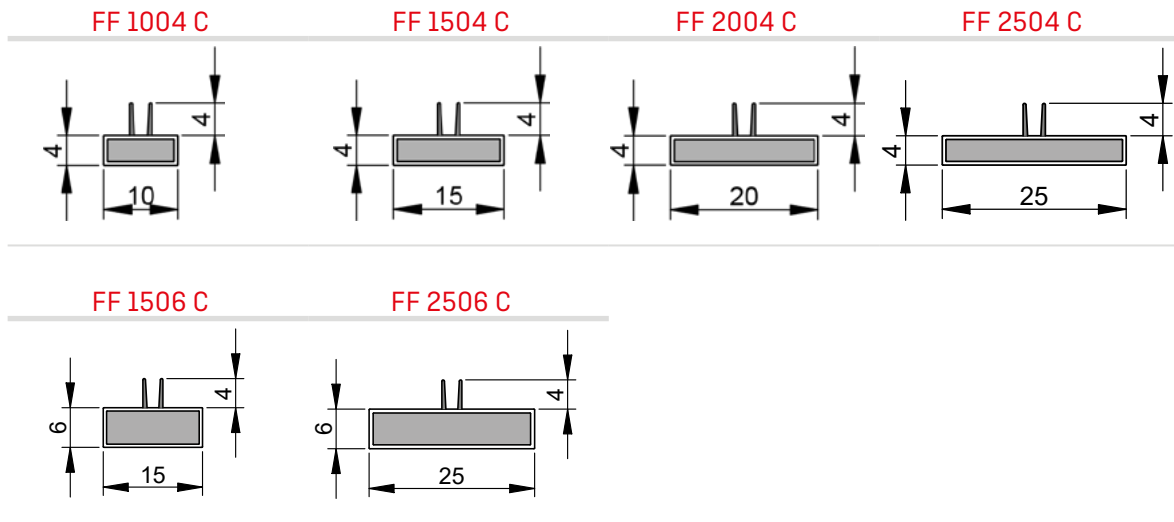

COLORS/ART.NO.	FF 1004 C	FF 1504 C	FF 2004 C	FF 2504 C	FF 1506 C	FF 2506 C
Red	F160183	F160141	F160145	F160288	-	-
Black	F160184	F160144	F160148	F160284	F160292	F160296
Dark brown	F160186	F160142	F160146	F160283	F160209	F160294
Brown	F160273	F160276	F160279	F160282	F160290	F160293
White	F160185	F160143	F160147	F160285	F160291	F160295
Grey	F160274	F160277	F160280	F160286	-	-
Cream	F160275	F160278	F160281	F160287	-	-

\*The test value may differ according to the EN 1634-1 test, as the complete door system must be checked.





## FF-D Series

- / rigid box graphite fire & smoke seal with double edge fin
- / provides fire, smoke and acoustic protection for doors
- / equipped with a durable self-adhesive backing tape
- / supplied in lengths

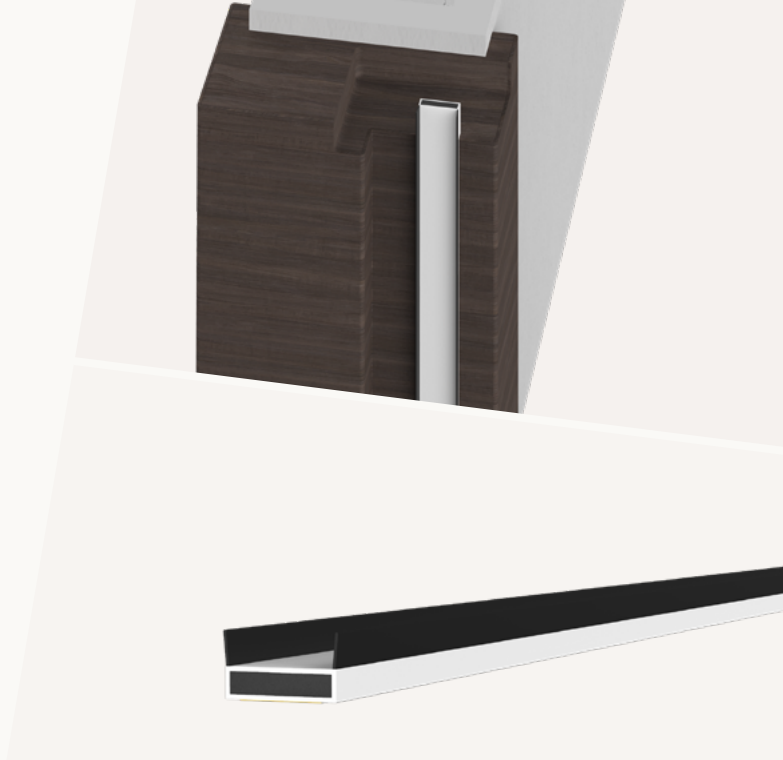

### TECHNICAL DATA

Application	fire rated timber doors & frames
Material	PVC encapsulated graphite, with soft PVC fins

### PERFORMANCE & CERTIFICATES

Fire	EN 1634-1*
------	------------

### DIMENSIONS

Standard lengths	2100, 2400, 3000 mm
------------------	---------------------

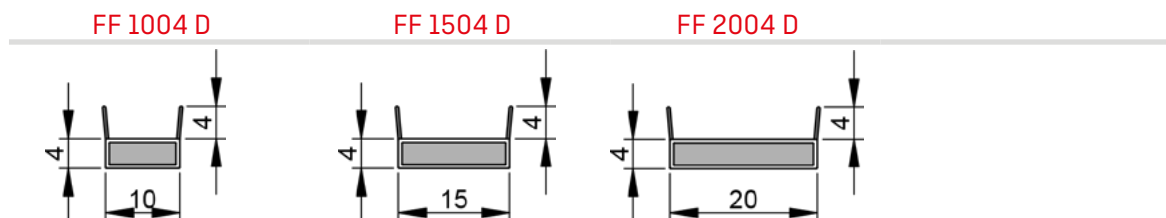

COLORS/ART.NO.	FF 1004 D	FF 1504 D	FF 2004 D
Red	F160076	F160079	F160082
Black	F160113	F160114	F160115
Brown	F160077	F160080	F160083
White	F160078	F160081	F160084

\*The test value may differ according to the EN 1634-1 test, as the complete door system must be checked.

## FPP Series

- / plain, rigid box Palusol® fire seal
- / provides fire protection for doors
- / equipped with a durable self-adhesive backing tape
- / supplied in lengths

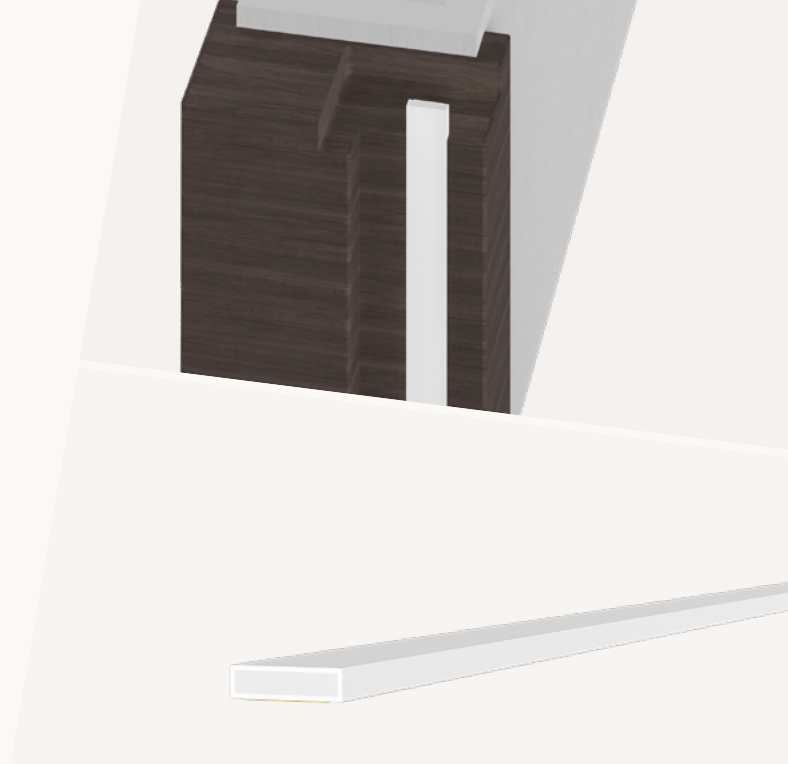

### TECHNICAL DATA

Application	fire rated timber doors & frames
Material	PVC encapsulated Palusol®

### PERFORMANCE & CERTIFICATES

Fire	EN 1634-1*
------	------------

### DIMENSIONS

Standard lengths	1050, 2150, 2400 mm
------------------	---------------------

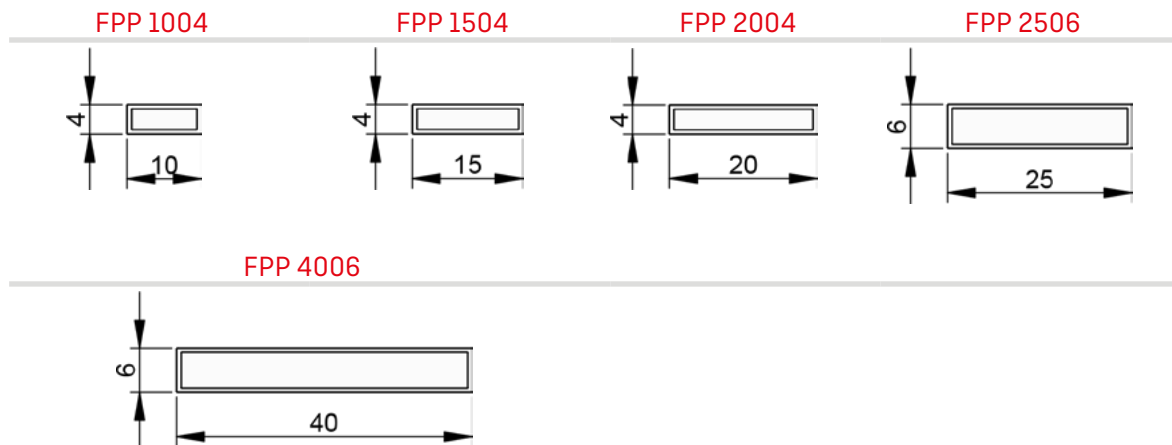

COLORS/ART.NO.	FPP 1004	FPP 1504	FPP 2004	FPP 2506	FPP 4006
Black	F160155	F160157	F160159	F160162	F160164
Dark brown	F160133	F160156	F160134	F160137	F160135
White	F160154	F160158	F160160	F160161	F160163

\*The test value may differ according to the EN 1634-1 test, as the complete door system must be checked.

## FFP-C Series

- / rigid box Palusol® fire & smoke seal with double central fin
- / provides fire, smoke and acoustic protection for doors
- / equipped with a durable self-adhesive backing tape
- / supplied in lengths

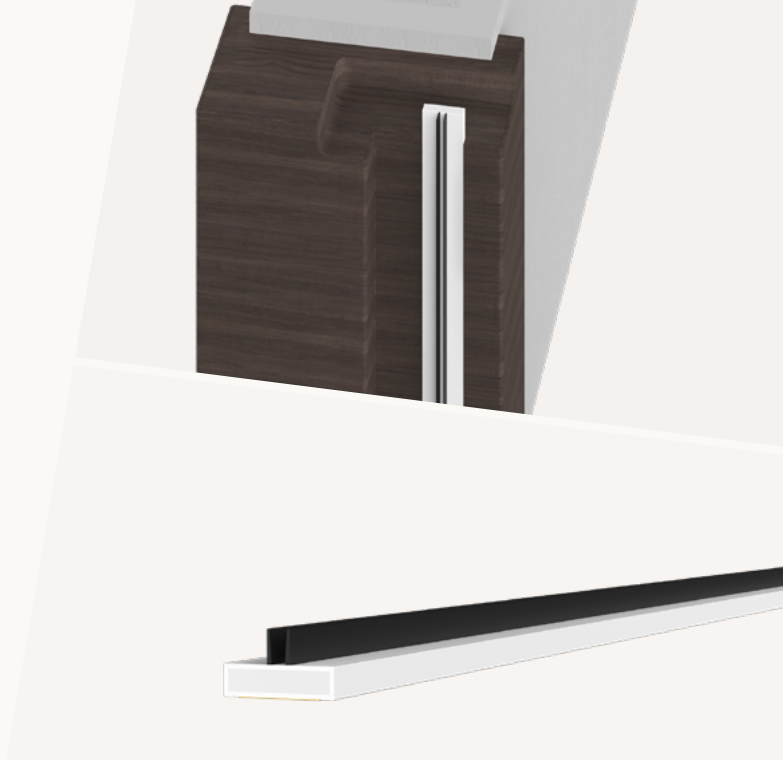

### TECHNICAL DATA

Application	fire rated timber doors & frames
Material	PVC encapsulated Palusol®, with soft PVC fins

### PERFORMANCE & CERTIFICATES

Fire	EN 1634-1*
------	------------

### DIMENSIONS

Standard lengths	1050, 2150, 2400 mm
------------------	---------------------

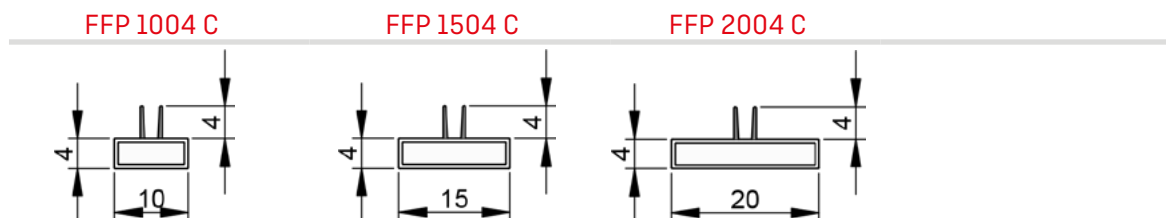

COLORS/ART.NO.	FFP 1004 C	FFP 1504 C	FFP 2004 C
Black	F160169	F160175	F160167
Dark brown	F160168	F160174	F160165
White	F160170	F160176	F160166

\*The test value may differ according to the EN 1634-1 test, as the complete door system must be checked.

## FFP-D Series

- / rigid box Palusol® fire & smoke seal with double edge fin
- / provides fire, smoke and acoustic protection for doors
- / equipped with a durable self-adhesive backing tape
- / supplied in lengths

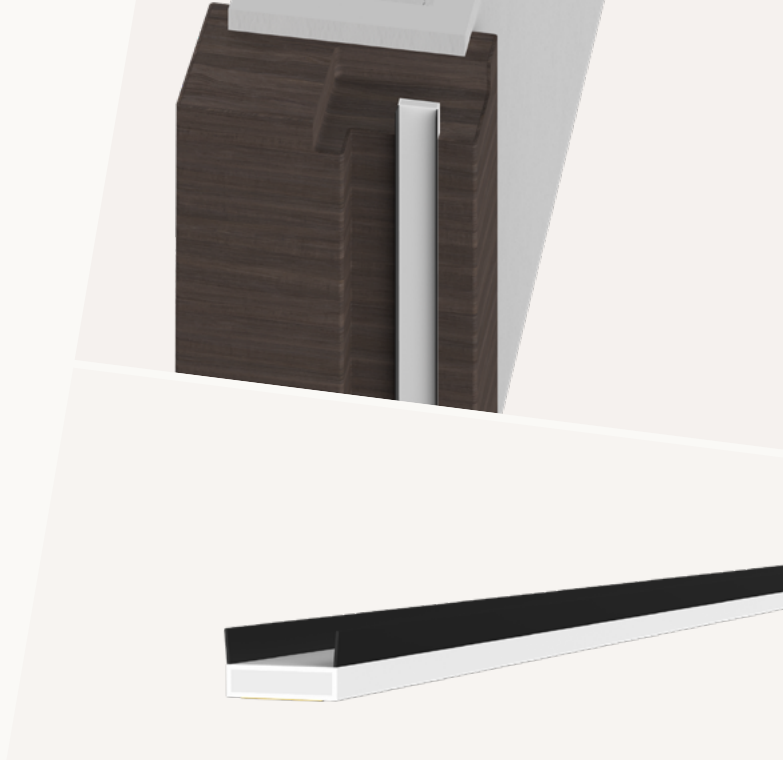

### TECHNICAL DATA

Application	fire rated timber doors & frames
Material	PVC encapsulated Palusol®, with soft PVC fins

### PERFORMANCE & CERTIFICATES

Fire	EN 1634-1*
------	------------

### DIMENSIONS

Standard lengths	1050, 2150, 2400 mm
------------------	---------------------

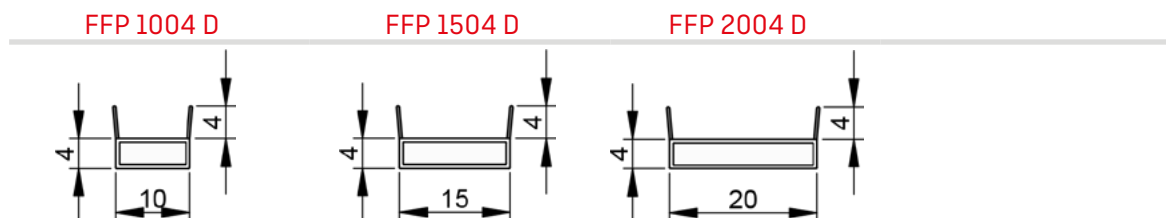

COLORS/ART.NO.	FFP 1004 D	FFP 1504 D	FFP 2004 D
Black	F160172	F160178	F160181
Dark brown	F160171	F160177	F160180
White	F160173	F160179	F160182

\*The test value may differ according to the EN 1634-1 test, as the complete door system must be checked.







# Interdens®

- / phosphate (MAP) -based intumescent sheet
- / provides fire protection for door ironmongery
- / equipped with a durable self-adhesive backing tape
- / supplied in strips, sheet form or can be cut to size
- / Interdens® is the registered trademark of BASF Wolman GmbH, Sinzheim



## TECHNICAL DATA

Application	fire rated timber & metal doors
Material	Interdens®

## PERFORMANCE & CERTIFICATES

Fire	EN 1634-1*
------	------------

## DIMENSIONS

Standard lengths	1050 mm strips 2040 x 1000 mm sheet
------------------	--

## COLORS/ART.NO.

1 mm sheet	P160076
2 mm sheet	P160077

\*The test value may differ according to the EN 1634-1 test, as the complete door system must be checked.



# Palusol®

- / sodium silicate-based intumescent sheet
- / provides fire protection for fire doors and glazing
- / equipped with a durable self-adhesive backing tape
- / supplied in strips and in sheet form
- / Palusol® is the registered trademark of BASF Wolman GmbH, Sinzheim



## TECHNICAL DATA

Application	fire rated timber & metal doors
Material	Palusol®

## PERFORMANCE & CERTIFICATES

Fire	EN 1634-1*
------	------------

## DIMENSIONS

Standard lengths	1050 mm strips 2100 x 1100 mm sheet
------------------	--

## COLORS/ART.NO.

2 mm sheet	F160140
------------	---------

\*The test value may differ according to the EN 1634-1 test, as the complete door system must be checked.

## Threshold plates

# Performance without restriction

Our range of aluminium and stainless steel threshold plates provide a **stylish connection between** two rooms or spaces, covering the gap between different floor types and thicknesses. The range can be supplied with or without pre-drilled holes, providing the option for a more practical, screwed installation or a more aesthetic, screw-free installation with adhesive.

Threshold plates provide an optimal sealing surface for our drop seals to seal against. The majority of the range is low-profile, designed with a focus on minimising impact on movement through a building. Our range also consists of certified **barrier-free solutions** to cater to recent construction trends and the rapidly growing sector of barrier-free living.



## Threshold plates





# COMFORT-PLAN®

## THERMALLY SEPARATED THRESHOLD SET

### **GUARANTEED BARRIER-FREE PLANNING**

- / Architects and designers can guarantee barrier-free construction to the latest DIN standards

### **ACCESSIBILITY FOR ALL**

- / Rollability tests prove the set's accessibility – ideal for wheelchair users, prams and rollators

### **BUILT-IN WEATHERPROOFING**

- / The Comfort-Plan® set is supplied with the Rainstop® dropseal to satisfy weatherproofing requirements

### **TWO STANDARD SIZES AVAILABLE**

- / A ready-made 78 & 88 mm solution is available for both commercial and private timber entrance doors.

### **THERMAL SEPARATION**

- / Comfort-Plan® is thermally-efficient, featuring a central thermal break

# Comfort-Plan®

- / weatherproof, barrier-free threshold solution
- / barrier-free compliant  
[DIN 18040-1 & DIN 18040-2]
- / resistance to driving rain [EN 12208]
- / provides thermal break

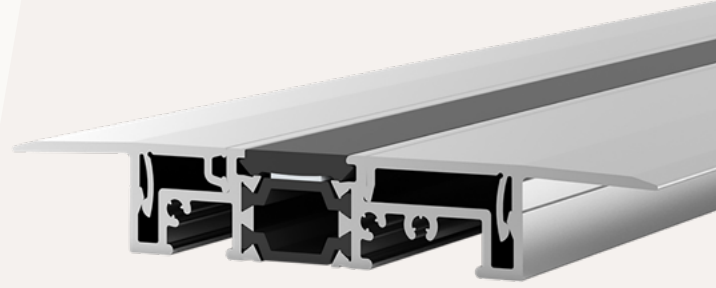

## TECHNICAL DATA

Application	door threshold
Standard lengths	1300, 1450, 1600, 1750mm

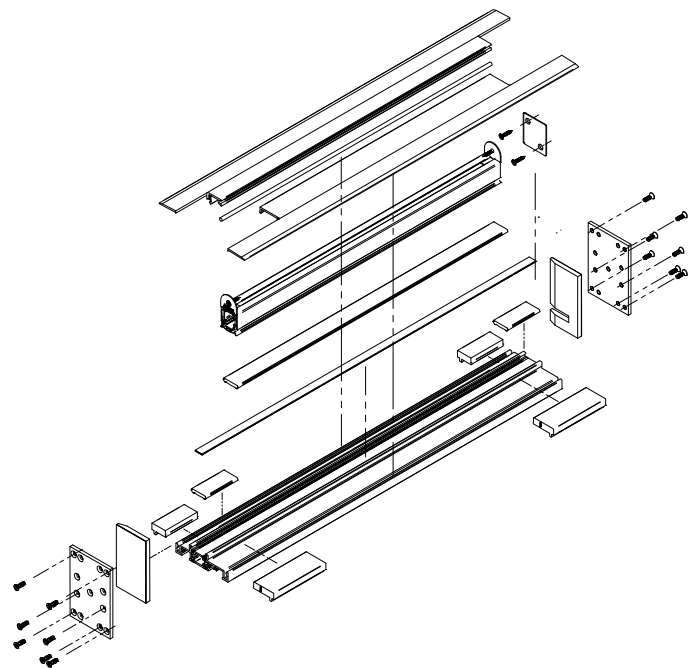
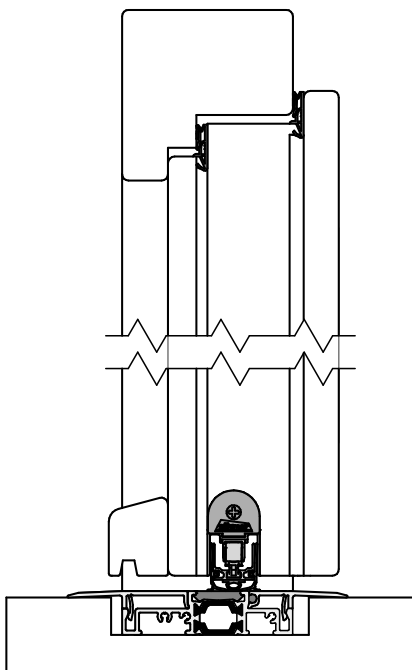

## ART.NO.

Comfort-Plan® 78	3-278
Comfort-Plan® 88	3-288

## Thresholds

- / recommended for optimal acoustic performance
- / range of options for use with both carpets and tiled floors
- / low profile, suitable for disabled access
- / stainless steel (Niro) or aluminium (Alu) profiles supplied with protective film

TECHNICAL DATA	Niro	Alu
Application	at the threshold of doorsets	
Material	stainless steel	aluminium
Fixing	bonded with adhesive or fixed with screws (not supplied)	

ART.NO.	Niro 164	Niro 365	Niro 288	Niro 513
	3-107	3-135	3-103	3-150
	Alu 090	Alu 253	Alu 088	Alu 277
	3-111	3-114	3-117	3-104
	Alu 308	Alu 278	Alu 217	Alu 496
	3-120	3-108	3-100	3-152



**DIMENSIONS**

**Niro 164**

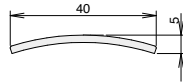

**Niro 365**

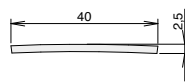

**Niro 288**

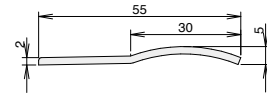

**Niro 513**

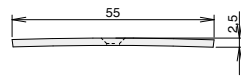

**Alu 090**

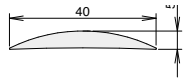

**Alu 253**

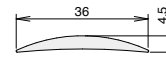

**Alu 088**

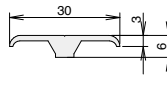

**Alu 277**

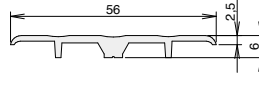

**Alu 308**

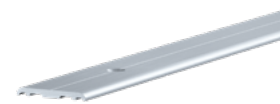
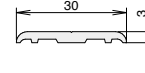

**Alu 278**

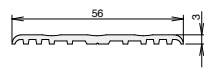

**Alu 217**

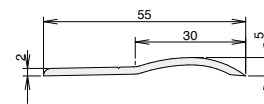

**Alu 496**

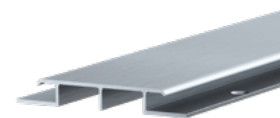
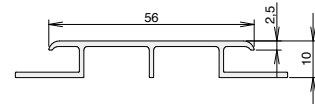



# AT 07506

/ saddle threshold with low profile

## TECHNICAL DATA

Application	at the threshold of hinged single and double action doors
Material	aluminum, anodized

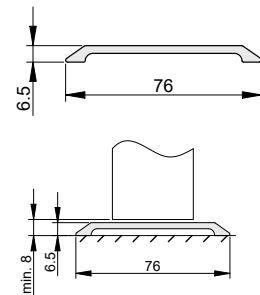

## DIMENSIONS

Width x height	76 x 6.5 mm
Bottom gap size	≥8 mm
Standard lengths	1.000, 2.250, 2.500, 3.000 mm
Max. lengths	3.000 mm
Can be shortened by	any lengths

## FIXING

Fixing	screw fixed to the floor with screws and anchors
--------	--

## PERFORMANCE & CERTIFICATES

UL	UL 10C (R38166)
----	-----------------

## COLORS

## ART.NO.

Silver anodized	P160197
-----------------	---------



# AT 10006

/ saddle threshold with low profile

## TECHNICAL DATA

Application	at the threshold of hinged single and double action doors
Material	aluminum, anodized

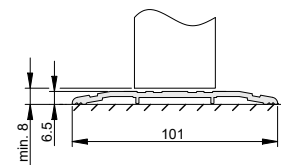
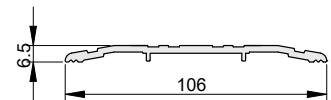

## DIMENSIONS

Width x height	106 x 6.5 mm
Bottom gap size	≥8 mm
Standard lengths	1.000, 2.250, 2.500, 3.000 mm
Max. lengths	3.000 mm
Can be shortened by	any lengths

## FIXING

Fixing	screw fixed to the floor with screws and anchors
--------	--

## PERFORMANCE & CERTIFICATES

UL	UL 10C (R38166)
----	-----------------

## COLORS

## ART.NO.

Silver anodized	P160198
-----------------	---------



# AT 12706

/ saddle threshold with low profile



## TECHNICAL DATA

Application	at the threshold of hinged single- and double action doors
Material	aluminum, anodized



## DIMENSIONS

Width x height	127 x 6.5 mm
Bottom gap size	≥8 mm
Standard lengths	1.000, 1.250, 2.250, 2.500, 3.000 mm
Max. lengths	3.000 mm
Can be shortened by	any lengths

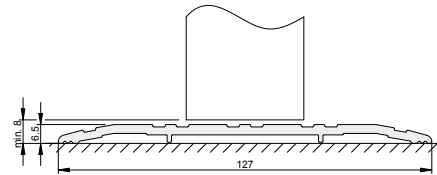

## FIXING

Fixing	screw fixed to the floor with screws and dowels
--------	---

## PERFORMANCE & CERTIFICATES

UL	UL 10C (R38166)
----	-----------------

## COLORS

Silver anodized	ART.NO. P160084
-----------------	-----------------



# AT 15006

/ saddle threshold with low profile

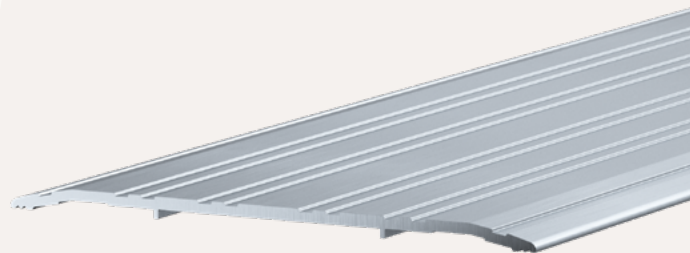

## TECHNICAL DATA

Application	at the threshold of hinged single action doors
Material	aluminum, anodized

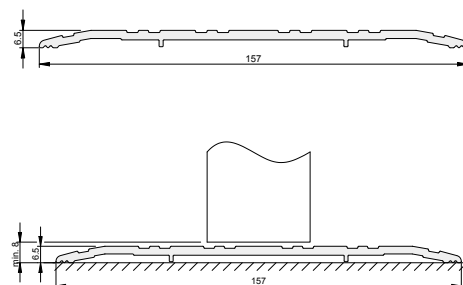

## DIMENSIONS

Width x height	157 x 6.5 mm
Bottom gap size	≥ 8 mm
Standard lengths	1.000, 1.250, 2.250, 2.500, 3.000 mm
Max. lengths	3.000 mm
Can be shortened by	any lengths

## FIXING

Fixing	screw fixed to the floor with screws and dowels
--------	---

## PERFORMANCE & CERTIFICATES

UL	UL 10C (R38166)
----	-----------------

## COLORS

Silver anodized	ART.NO. P160092
-----------------	-----------------

6 Threshold plates  
6.2 stainless steel & aluminium plates

athmer.com



# AT 12713

/ saddle threshold with high profile



## TECHNICAL DATA

Application	at the threshold of hinged single- and double action doors
Material	aluminum, anodized



## DIMENSIONS

Width x height	127 x 13 mm
Bottom gap size	≥15 mm
Standard lengths	1.000, 1.250, 2.250, 2.500, 3.000 mm
Max. lengths	3.000 mm
Can be shortened by	any lengths

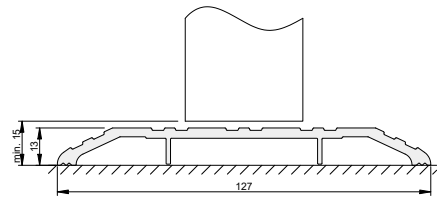

## FIXING

Fixing	screw fixed to the floor with screws and dowels
--------	---

## PERFORMANCE & CERTIFICATES

UL	UL 10C (R38166)
----	-----------------

## COLORS

Silver anodized	ART.NO. P160086
-----------------	-----------------





# AT 15213

/ paddle threshold with low profile

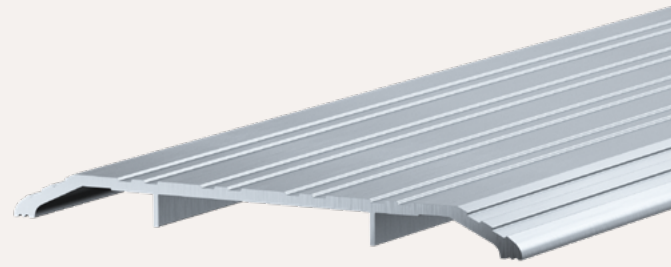

## TECHNICAL DATA

Application	at the threshold of hinged single action doors
Material	aluminum, anodized

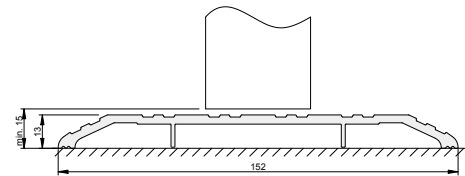
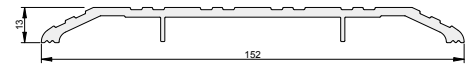

## DIMENSIONS

Width x height	152 x 13 mm
Bottom gap size	≥15 mm
Standard lengths	1.000, 1.250, 2.250, 2.500, 3.000 mm
Max. lengths	3.000 mm
Can be shortened by	any lengths

## FIXING

Fixing	screw fixed to the floor with screws and dowels
--------	---

## PERFORMANCE & CERTIFICATES

UL	UL 10C [R38166]
----	-----------------

## COLORS

Silver anodized	ART.NO. P160090
-----------------	-----------------



# AT 12712 S

- / panic threshold with Silicone compression gasket
- / effective sealing against draught, light and noise



## TECHNICAL DATA

Application	at the threshold of hinged single action doors
Gasket material	self-extinguishing silicone
Carrier material	aluminum, anodized
Working temperature	-40°C to +200°C

## DIMENSIONS

Width x height	125 x 12 mm
Bottom gap size	6 - 10 mm
Standard lengths	1.000, 1.250, 2.250, 2.500, 3.000 mm
Max. lengths	3.000 mm
Can be shortened by	any lengths

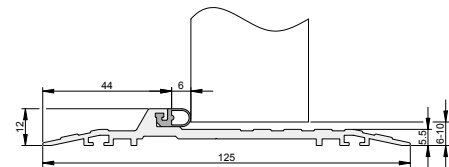
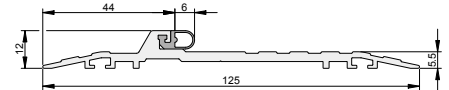

## FIXING

Fixing	screw fixed to the floor with screws and dowels
--------	---

## PERFORMANCE & CERTIFICATES

UL	UL 10C (R38166)
----	-----------------

COLORS [carrier, gasket]	ART.NO.	ACCESSORIES [incl. in delivery]
Silver anodized, grey	3-201	S022



# AT 12713 S

- / panic threshold with silicone compression gasket
- / comes with water tight bedding gasket for effective acoustic sealing and vibration control
- / effective sealing against rain, draught, light and noise



## TECHNICAL DATA

Application	at the threshold of hinged single action doors
Gasket material	self-extinguishing silicone; bottom seal: PVC
Carrier material	aluminum, anodized
Working temperature	-15°C to +60°C

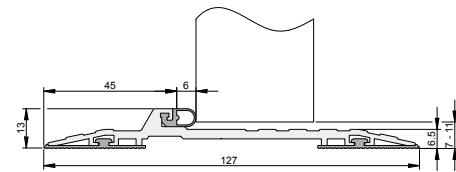
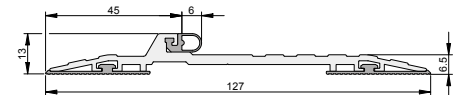

## DIMENSIONS

Width x height	127 x 13 mm
Bottom gap size	7 - 11 mm
Standard lengths	1.000, 1.250, 2.250, 2.500, 3.000 mm
Max. lengths	3.000 mm
Can be shortened by	any lengths

## FIXING

Fixing	screw fixed to the floor with screws and dowels
--------	---

## PERFORMANCE & CERTIFICATES

UL	UL 10C [R38166]
----	-----------------

COLORS [carrier, gasket]	ART.NO.	ACCESSORIES [incl. in delivery]
Silver anodized, grey	3-202	S022



## AT 12713 V

/ panic threshold with gasket provides additional threshold acoustics

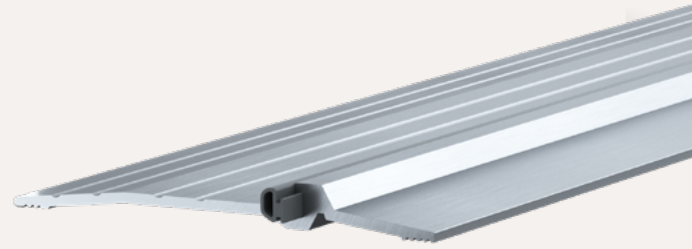

### TECHNICAL DATA

Application	at the threshold of hinged single action doors
Gasket material	vinyl PVC
Carrier material	aluminum, anodized
Working temperature	-15°C to +60°C

### DIMENSIONS

Width x height	127 x 13 mm
Bottom gap size	7 - 10 mm
Standard lengths	1.000, 1.250, 2.250, 2.500, 3.000 mm
Max. lengths	3.000 mm
Can be shortened by	any lengths

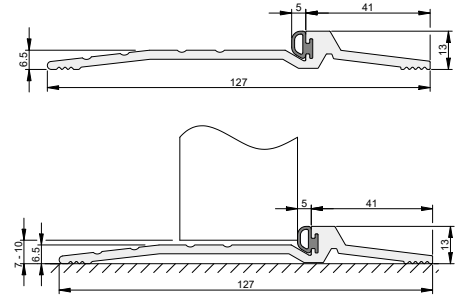

### FIXING

Fixing	screw fixed to the floor with screws and dowels
--------	---

### PERFORMANCE & CERTIFICATES

UL	UL 10C (R38166)
----	-----------------

COLORS [carrier, gasket]	ART.NO.
Silver anodized, grey	P160087









# AT 07019 V

/ ramp threshold with compression gasket

## TECHNICAL DATA

Application	at the threshold of hinged single action doors
Carrier material	aluminum, anodized
Gasket material	vinyl PVC
Working temperature	-15°C to +60°C

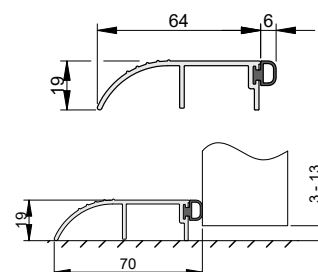

## DIMENSIONS

Width x height	70 x 19 mm
Bottom gap size	3 - 13 mm
Standard lengths	1.000, 2.250, 2.500, 3.000 mm
Max. lengths	3.000 mm
Can be shortened by	any lengths

## FIXING

Fixing	screw fixed to the floor with screws and anchors
--------	--

## PERFORMANCE & CERTIFICATES

UL	UL 10C [R38166]
----	-----------------

COLORS [carrier, gasket]	ART.NO.
Silver anodized, grey	P160199





# AT 09019 V

/ ramp threshold with compression gasket

## TECHNICAL DATA

Application	at the threshold of hinged single action doors
Carrier material	aluminum, anodized
Gasket material	vinyl PVC,
Working temperature	-15°C to +60°C

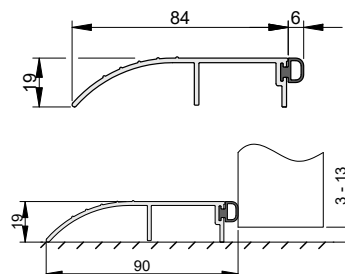

## DIMENSIONS

Width x height	90 x 19 mm
Bottom gap size	3 - 13 mm
Standard lengths	1.000, 2.250, 2.500, 3.000 mm
Max. lengths	3.000 mm
Can be shortened by	any lengths

## FIXING

Fixing	screw fixed to the floor with screws and anchors
--------	--

## PERFORMANCE & CERTIFICATES

UL	UL 10C [R38166]
----	-----------------

## COLORS [carrier, gasket]

Silver anodized, grey

## ART.NO.

P160200



## RG 7040

- / overhead rain drip guard
- / channels rain water from entrance doors
- / suitable for single and double leaf doors

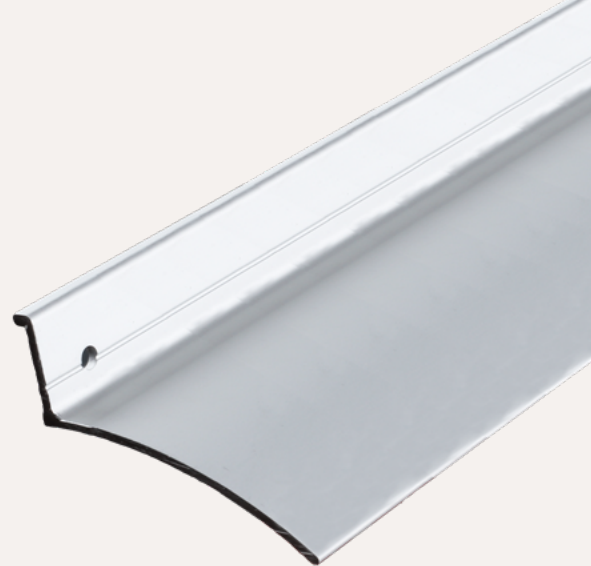

### TECHNICAL DATA

Application	at the head of external doors
Material	aluminum, anodized

### DIMENSIONS

Standard lengths	1000, 1250, 2250, 2500, 3000 mm
Maximum lengths	3.000 mm
Can be shortened by	any length

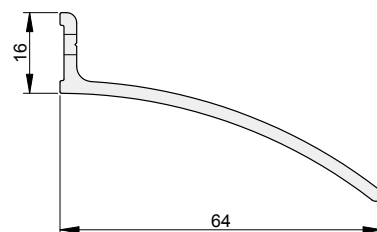

### FIXING

Fixing	screw fixed to the wall above the door
--------	--

### PERFORMANCE & CERTIFICATES

UL	UL 10C (R38166)
----	-----------------

### COLORS

Silver anodized

### ART.NO.

P160123

## RG 7721

- / overhead rain drip guard
- / channels rain water from entrance doors
- / suitable for single and double leaf doors

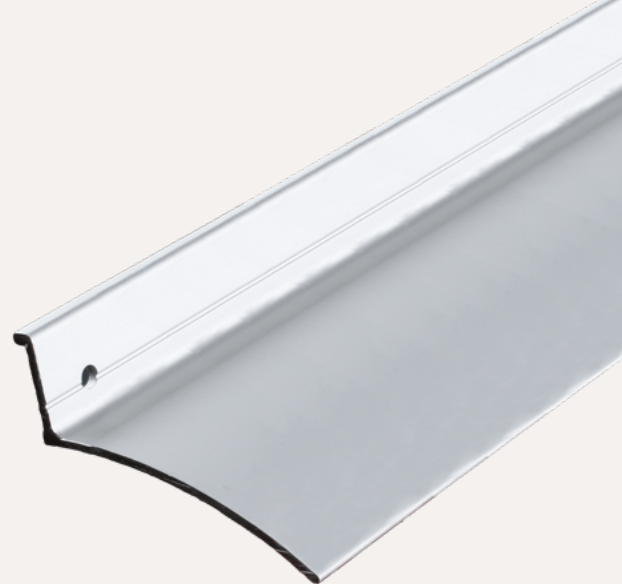

### TECHNICAL DATA

Application	at the head of external doors
Material	aluminum, anodized

### DIMENSIONS

Standard lengths	1000, 1250, 2250, 2500, 3000 mm
Maximum lengths	3.000 mm
Can be shortened by	any length

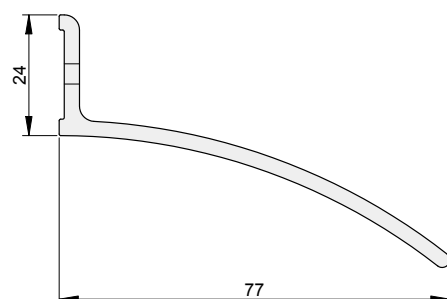

### FIXING

Fixing	screw fixed to the wall above the door
--------	--

### COLORS

Silver anodized

### ART.NO.

P160124

## Finger protection systems

# Securing all danger points on doors

Applied and tested for years - thanks to their quality and durability athmer finger protection roller blinds were the first products on the market to **effectively secure** the gap on the opposite hinge side of doors against fingers being trapped. Since then, planners and fabricators have deliberately opted for athmer finger protection because they **ensure safety** not only in kindergartens, schools, hospitals and care facilities. In addition, the roller blinds offer superior protection against residual risks on **automatic doors**.

These solutions are available for timber, metal and glass doors and provide both visual and physical barriers to the gaps around a door. We offer **options** for both the hinge and opposite hinge side as well as at the head with our Porti® range of door opening restrictors. The main closing edge can be secured with our door stop HS-25.

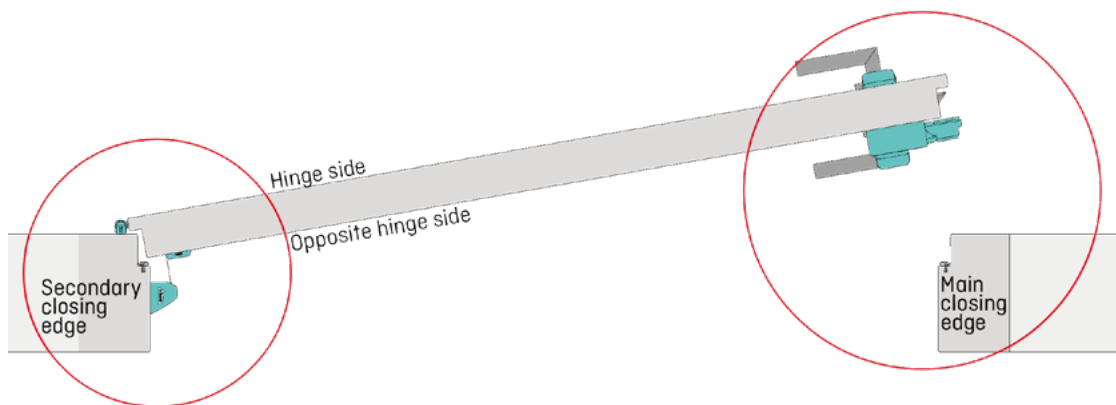



## Finger protection systems

# NR-32 UniSafe®

## 5-901

- / easy to install and dismantle
- / one design for all applications
- / click system with concealed screws
- / roller blind automatically maintains constant tension
- / flexible choice of colours

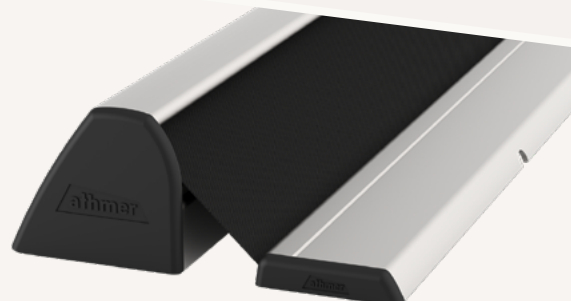
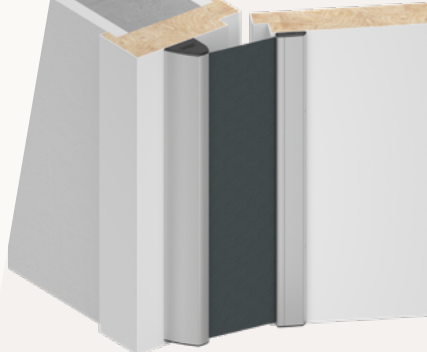

### APPLICATION

Danger point	secondary closing edge, opposite hinge side
Door type	PVC profile door, flush door, rebated door, flush profile door, multifunction door
Door leaf material	timber, aluminium, PVC, steel
Door frame material	timber, aluminium, PVC, steel
Suitable for fire protection	yes
Doors with panic hardware/ ram protection bracket	yes

### TECHNICAL DATA

Material profile	aluminium
Surface colors (color profile)	aluminium anodized or color coated, flexible color design possible
Standard colors	C-0, C-31, RAL9016, RAL7016 (special colors optional)
Material cover	synthetic fiber
Color cover	black, white-black, yellow-black, bordeaux-black, blue-black, green-black, black XL
Delivery length	325 mm - 3000 mm
Delivery length	1925 mm/ 2050 mm
Standard length for power operated doors EN16005	2000, 2500 mm
Special lengths available	yes
Protective cap end	yes

### FIXING

Retrofittable	yes
Mounting	clicked
Diassembly	unlock
Fixing	invisibly screwed
Accessories	ram protection

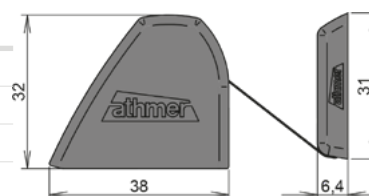

### COLORS

### ART.NO.

C-31	5-985
RAL 9016	5-909
RAL 7016	5-904
Special colors	5-999



# NR-25

## 5-101

- / proven protective system for decades
- / compact form
- / optional version for fitting to glass doors
- / roller blind automatically maintains constant tension

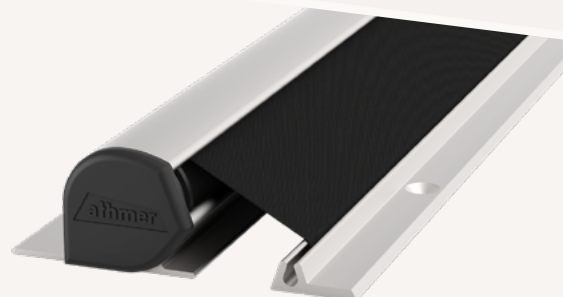
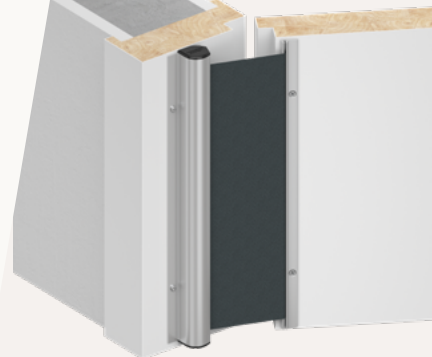

### APPLICATION

Danger point	secondary closing edge, opposite hinge side
Door type	PVC profile door, flush door, rebated door, flush profile door, multifunction door
Door leaf material	timber, aluminium, PVC, steel
Door frame material	timber, aluminium, PVC, steel
Suitable for fire protection	yes
Doors with panic hardware/ ram protection bracket	yes

### TECHNICAL DATA

Material profile	aluminium
Surface colors (color profile)	aluminium anodized or color coated, flexible color design possible
Standard colors	C-0, C-31, RAL9016, RAL7016 (special colors optional)
Material cover	synthetic fiber
Color cover	black
Delivery length	325 mm - 2500 mm
Delivery length	1925/ 2050 mm
Standard length for power operated doors EN16005	2015 mm
Special lengths available	yes

### FIXING

Retrofittable	yes
Mounting	screwed
Disassembly	screwed
Fixing	visibly screwed

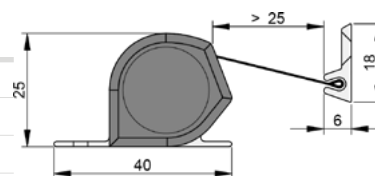

### COLORS

### ART.NO.

C-31	5-185
RAL 9016	5-109
RAL 7016	5-104
Special colors	5-499

# BU-16K<sup>+</sup>

## 5-310

- / easy installation without markings or installation aids
- / adjustable 2D fixing element
- / invisible screws
- / for timber and metal frames

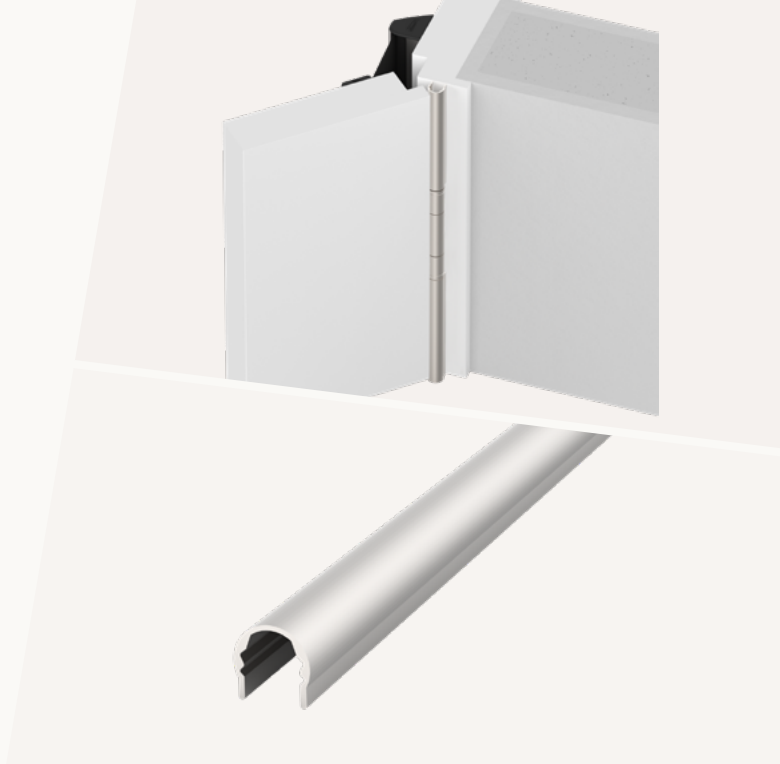

### APPLICATION

Danger point	secondary closing edge, hinge side
Door leaf material	timber, aluminium, PVC, steel
Door frame material	timber, aluminium, PVC, steel
Suitable for fire protection	yes
Cleaning	washable
Outdoor	weatherproof

### TECHNICAL DATA

Material profile	aluminium
Surface colors (color profile)	aluminium anodized or color coated, flexible color design possible
Standard colors	C-0, C-31, RAL9016 (special colors optional)
Delivery length	90 mm - 3000 mm
Special lengths available	yes
Standard length self cutting	1755, 1980 mm available as set (suitable for mounting below, between and above the hinges)
For hinge diameter	15 - 16 mm

### FIXING

Retrofittable	yes
Diassembly	lever off
Fixing	invisibly screwed

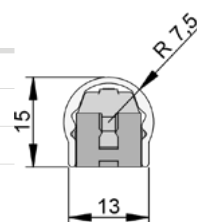

### COLORS

### ART.NO.

C-31	5-312
RAL 9016	5-311
Special colors	5-313

# BU-18K<sup>+</sup>

## 5-320

- / easy installation without markings or installation aids
- / adjustable 2D fixing element
- / invisible screws
- / for timber and metal frames

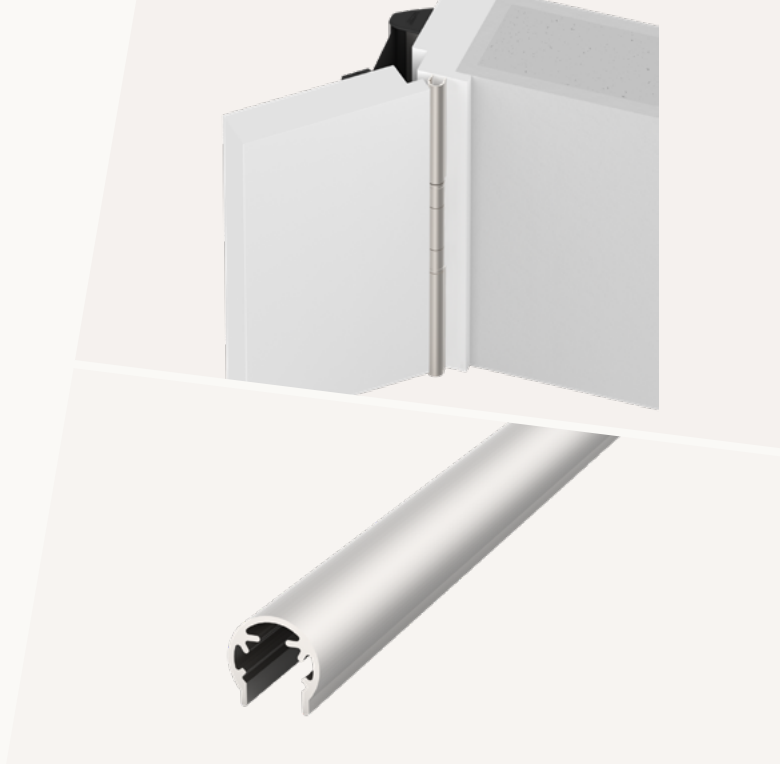

### APPLICATION

Danger point	secondary closing edge, hinge side
Door leaf material	timber, aluminium, PVC, steel
Door frame material	timber, aluminium, PVC, steel
Suitable for fire protection	yes
Cleaning	washable
Outdoor	weatherproof

### TECHNICAL DATA

Material profile	aluminium
Surface colors (color profile)	aluminum anodized or color coated, flexible color design possible
Standard colors	C-0, C-31, RAL9016 (special colors optional)
Delivery length	90 mm - 3000 mm
Special lengths available	yes
Standard length self cutting	1755, 1980 mm available as set (suitable for mounting below, between and above the hinges)
For hinge diameter	17 - 18 mm

### FIXING

Retrofittable	yes
Diassembly	lever off
Fixing	invisibly screwed

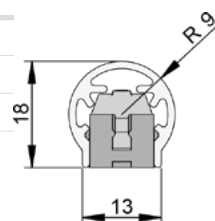

COLORS	ART.NO.
C-31	5-322
RAL 9016	5-321
Special colors	5-321

# BU-20K<sup>+</sup>

## 5-330

- / easy installation without markings or installation aids
- / adjustable 2D fixing element
- / invisible screws
- / for timber and metal frames



### APPLICATION

Danger point	secondary closing edge, hinge side
Door leaf material	timber, aluminium, PVC, steel
Door frame material	timber, aluminium, PVC, steel
Suitable for fire protection	yes
Cleaning	washable
Outdoor	weatherproof

### TECHNICAL DATA

Material profile	aluminium
Surface colors (color profile)	aluminum anodized or color coated, flexible color design possible
Standard colors	C-0, C-31, RAL9016 (special colors optional)
Delivery length	90 mm - 3000 mm
Special lengths available	yes
Standard length self cutting	1755, 1980 mm available as set (suitable for mounting below, between and above the hinges)
For hinge diameter	19 - 20 mm

### FIXING

Retrofittable	yes
Mounting	invisibly screwed
Diassembly	lever off

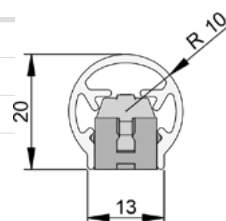

### COLORS

### ART.NO.

C-31	5-332
RAL 9016	5-331
Special colors	5-331

# BU-22K+

5-340

- / easy installation without markings or installation aids
- / adjustable 2D fixing element
- / invisible screws
- / for timber and metal frames



## APPLICATION

Danger point	secondary closing edge, hinge side
Door leaf material	timber, aluminium, PVC, steel
Door frame material	timber, aluminium, PVC, steel
Suitable for fire protection	yes
Cleaning	washable
Outdoor	weatherproof

## TECHNICAL DATA

Material profile	aluminium
Surface colors (color profile)	aluminum anodized or color coated, flexible color design possible
Standard colors	C-0, C-31, RAL9016 (special colors optional)
Delivery length	90 mm - 3000 mm
Special lengths available	yes
Standard length self cutting	1755, 1980 mm available as set (suitable for mounting below, between and above the hinges)
For hinge diameter	21 - 22 mm

## FIXING

Retrofittable	yes
Mounting	invisibly screwed
Diassembly	lever off

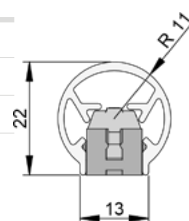

COLORS	ART.NO.
C-31	5-343
RAL 9016	5-341
Special colors	5-344

# BU-24K<sup>+</sup>

## 5-350

- / easy installation without markings or installation aids
- / adjustable 2D fixing element
- / invisible screws
- / for timber and metal frames



### APPLICATION

Danger point	secondary closing edge, hinge side
Door leaf material	timber, aluminium, PVC, steel
Door frame material	timber, aluminium, PVC, steel
Suitable for fire protection	yes
Cleaning	washable
Outdoor	weatherproof

### TECHNICAL DATA

Material profile	aluminium
Surface colors (color profile)	aluminium anodized or color coated, flexible color design possible
Standard colors	C-0, C-31, RAL9016 (special colors optional)
Delivery length	90 mm - 3000 mm
Special lengths available	yes
Standard length self cutting	1755, 1980 mm available as set (suitable for mounting below, between and above the hinges)
For hinge diameter	23 - 24 mm

### FIXING

Retrofittable	yes
Mounting	invisibly screwed
Diassembly	lever off

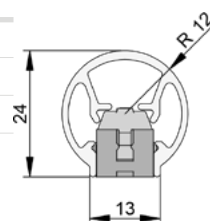

### COLORS

### ART.NO.

C-31	5-353
RAL 9016	5-351
Special colors	5-348



# B0-13

## 5-455

- / protective profiles for butt doors with screw-on flap hinges
- / design oriented adapted profile geometry to the hinge
- / for hinge  $\varnothing$  from 12 - 14 mm



### APPLICATION

Danger point	secondary closing edge, hinge side opening face
Door type	flush door
Door leaf material	timber
Door frame material	timber, metal
Suitable for fire protection	yes

### TECHNICAL DATA

Material profile	aluminium
Surface colors (color profile)	aluminium anodized or color coated, flexible color design possible
Standard colors	C-0, C-31, RAL9016 (special colors optional)
Delivery length	90 mm - 3000 mm
Special lengths available	yes
Standard length self cutting	1750, 1950 mm available as set (suitable for mounting below, between and above the hinges)
For hinge diameter	12-14 mm

### FIXING

Retrofittable	yes
Fixing	visibly screwed

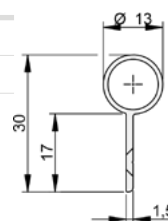

### COLORS

COLORS	ART.NO.
C-31	5-458
RAL 9016	5-456
Special colors	5-458

# B0-16

## 5-314

- / protective profiles for butt doors with screw-on flap hinges
- / design oriented adapted profile geometry to the hinges
- / for hinges  $\varnothing$  from 12 - 14 mm



### APPLICATION

Danger point	secondary closing edge, hinge side
Door type	flush door
Door leaf material	timber
Door frame material	timber, metal
Suitable for fire protection	yes

### TECHNICAL DATA

Material profile	aluminium
Surface colors (color profile)	aluminium anodized or color coated, flexible color design possible
Standard colors	C-0, C-31, RAL9016 (special colors optional)
Delivery length	90 mm - 3000 mm
Special lengths available	yes
Standard length self cutting	1750, 1950 mm available as set (suitable for mounting below, between and above the hinges)
For hinge diameter	15 - 16 mm

### FIXING

Retrofittable	yes
Fixing	visibly screwed
Accessories	endcap optional

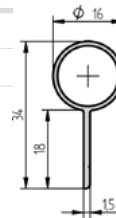

COLORS	ART.NO.
C-31	5-318
RAL 9016	5-315
Special colors	5-317

# B0-23

## 5-231

/ for doors without rebate with screw-on flap hinges

/ for timber and metal frames



### APPLICATION

Danger point	secondary closing edge, hinge side
Door type	flush door
Door leaf material	timber
Door frame material	timber, metal
Suitable for fire protection	yes

### TECHNICAL DATA

Material profile	aluminium
Surface colors (color profile)	aluminium anodized or color coated, flexible color design possible
Standard colors	C-0, C-31, RAL9016 (special colors optional)
Delivery length	90 mm - 3000 mm
Special lengths available	yes
Standard length self cutting	1750, 1950 mm available as set (suitable for mounting below, between and above the hinges)
For hinge diameter	22 - 24 mm

### FIXING

Retrofittable	yes
Fixing	visibly screwed
Accessories	end cap optional

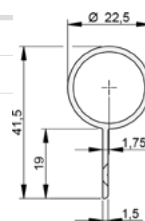

### COLORS

### ART.NO.

C-31	5-316
RAL 9016	5-242
Special colors	5-494

# B0-20

## 5-445

/ for doors with flush fit profile doors

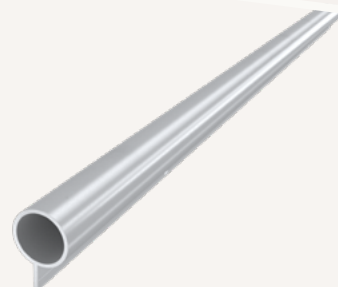
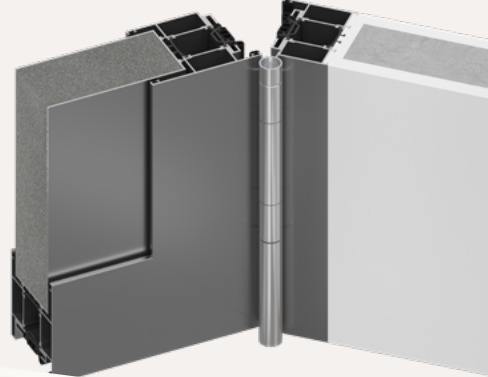

### APPLICATION

Danger point	secondary closing edge, hinge side
Door leaf material	aluminium
Door frame material	aluminium
Suitable for fire protection	yes
Cleaning	washable
Outdoor	weatherproof

### TECHNICAL DATA

Material profile	aluminium
Surface colors (color profile)	aluminium anodized or color coated, flexible color design possible
Standard colors	C-0, C-31, RAL9016 (special colors optional)
Delivery length	90 mm - 3000 mm
Special lengths available	yes
Standard length self cutting	1750, 1950 mm available as set (suitable for mounting below, between and above the hinges)
For hinge diameter	20 mm

### FIXING

Retrofittable	yes
Fixing	visibly screwed
Accessories	end cap optional

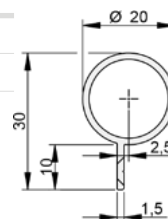

### COLORS

### ART.NO.

C-31	5-446
RAL 9016	5-447
Special colors	5-493

# B0-22

## 5-452

/ for doors with flush fit profile doors

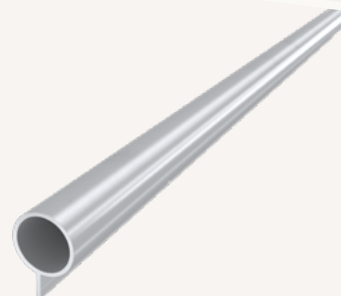
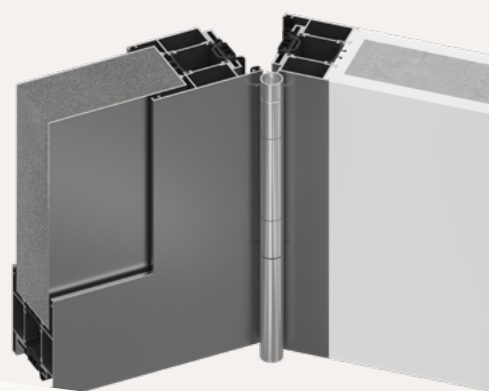

### APPLICATION

Danger point	secondary closing edge, hinge side
Door leaf material	aluminium
Door frame material	aluminium
Suitable for fire protection	yes
Cleaning	washable
Outdoor	weatherproof

### TECHNICAL DATA

Material profile	aluminium
Surface colors (color profile)	aluminium anodized or color coated, flexible color design possible
Standard colors	C-0, C-31, RAL9016 (special colors optional)
Delivery length	90 mm - 3000 mm
Special lengths available	yes
Standard length self cutting	1750, 1950 mm available as set (suitable for mounting below, between and above the hinges)
For hinge diameter	22-23 mm

### FIXING

Retrofittable	yes
Fixing	visibly screwed
Accessories	end cap optional

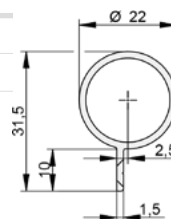

### COLORS

### ART.NO.

C-31	5-453
RAL 9016	5-454
Special colors	5-469

# BD-18

## 5-449

- / protective profiles for butt doors with hinges for adjustable receiving elements
- / design oriented adapted profile geometry to the hinge
- / standard notch for bottom seal for time savings during installation
- / end caps prevent butt edges



### APPLICATION

Danger point	secondary closing edge, hinge side
Door leaf material	timber
Door frame material	timber, metal
Suitable for fire protection	yes
Cleaning	washable
Outdoor	weatherproof

### TECHNICAL DATA

Material profile	aluminium
Surface colors (color profile)	aluminium anodized or color coated, flexible color design possible
Standard colors	C-0, C-31, RAL9016 (special colors optional)
Delivery length	90 mm - 3000 mm
Special lengths available	yes
Standard length self cutting	1750, 1950 mm available as set (suitable for mounting below, between and above the hinges)
For hinge diameter	17 - 19 mm

### FIXING

Retrofittable	yes
Fixing	visibly screwed
Accessories	end cap optional

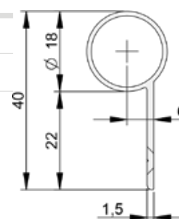

COLORS	ART.NO.
C-31	5-450
RAL 9016	5-451
Special colors	5-459



# BD-20

## 5-261

- / protective profiles for butt doors with hinges for adjustable receiving elements
- / design oriented adapted profile geometry to the hinge
- / standard notch for bottom seal for time savings during installation
- / end caps prevent butt edges



### APPLICATION

Danger point	secondary closing edge, hinge side
Door leaf material	timber
Door frame material	timber, metal
Suitable for fire protection	yes
Cleaning	washable
Outdoor	weatherproof

### TECHNICAL DATA

Material profile	aluminium
Surface colors (color profile)	aluminium anodized or color coated, flexible color design possible
Standard colors	C-0, C-31, RAL9016 (special colors optional)
Delivery length	90 mm - 3000 mm
Special lengths available	yes
Standard length self cutting	1750, 1950 mm available as set (suitable for mounting below, between and above the hinges)
For hinge diameter	19 - 21 mm

### FIXING

Retrofittable	yes
Fixing	visibly screwed
Accessories	end cap optional

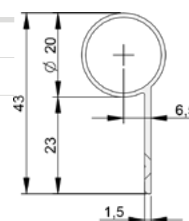

### COLORS

### ART.NO.

C-31	5-262
RAL 9016	5-263
Special colors	5-269

# BD-23

## 5-250

- / protective profiles for butt doors with hinges for adjustable receiving elements
- / design oriented adapted profile geometry to the hinge
- / standard notch for bottom seal for time savings during installation
- / end caps prevent butt edges



### APPLICATION

Danger point	secondary closing edge, hinge side
Door leaf material	timber
Door frame material	timber, metal
Suitable for fire protection	yes
Cleaning	washable
Outdoor	weatherproof

### TECHNICAL DATA

Material profile	aluminium
Surface colors (color profile)	aluminium anodized or color coated, flexible color design possible
Standard colors	C-0, C-31, RAL9016 (special colors optional)
Delivery length	90 mm - 3000 mm
Special lengths available	yes
Standard length self cutting	1750, 1950 mm available as set (suitable for mounting below, between and above the hinges)
For hinge diameter	22 - 23 mm

### FIXING

Retrofittable	yes
Mounting	visibly screwed
Diassembly	screwed
Fixing	visibly screwed
Accessories	end cap optional

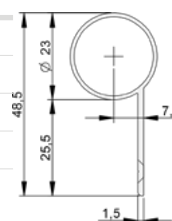

### COLORS

### ART.NO.

C-31	5-354
RAL 9016	5-303
Special colors	5-495

# BA-28<sup>+</sup>

## 5-112

- / for surface-mounted hinges on metal doors
- / variable adjustment options
- / concealed screw fixing

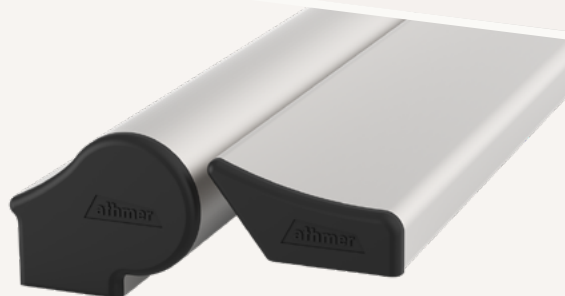

### APPLICATION

Danger point	secondary closing edge, hinge side
Door leaf material	aluminium
Door frame material	aluminium
Hinge type	top hinge
Suitable for fire protection	yes
Cleaning	washable
Outdoor	weatherproof

### TECHNICAL DATA

Material profile	aluminium
Surface colors (color profile)	aluminium anodized or color coated, flexible color design possible
Standard colors	C-0, C-31, RAL9016 (special colors optional)
Delivery length	1900/ 2400 mm
Standard length for power operated doors EN16005	1900 mm
Protective end cap	yes
Standard length self cutting	1900, 2400 available as set (suitable for mounting below, between and above the hinges)
For pivot point distance	22 - 38 mm

### FIXING

Retrofittable	yes
Mounting	invisibly screwed
Diassembly	lever off
Fixing	invisibly screwed

### COLORS

COLORS	ART.NO.
C-31	5-114
RAL 9016	5-113

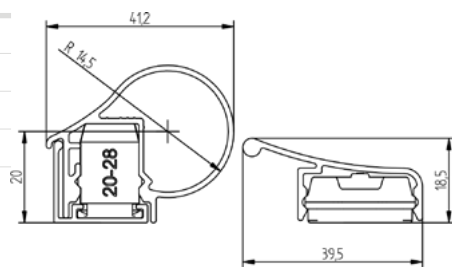

# BSG1

## 5-404

- / hinge-side protection system (with BU-K\*) for glassdoors
- / architectural, end-to-end solution for standard-compliant protection
- / complete coverage of the belts as well as the counterplates in combination with BU-K\*
- / profile with groove for notching for all common all-glass door hinges
- / simple and fast assembly

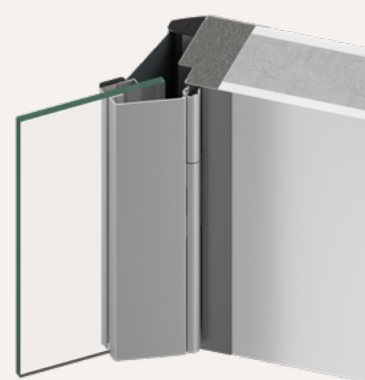

### APPLICATION

Danger point	secondary closing edge, hinge side
Door leaf material	glass
Door frame material	timber, aluminium, metal
Cleaning	washable

### TECHNICAL DATA

Material profile	aluminium
Surface colors (color profile)	aluminium anodized or color coated, flexible color design possible
Standard colors	C-0, C-31, RAL9016 (special colors optional)
Delivery length	90 mm - 3000 mm
Special lengths available	yes
Standard length	1972 mm

### FIXING

Retrofittable	yes
Mounting	glued
Fixing	glued

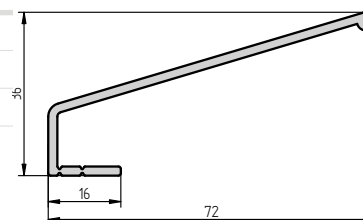

### COLORS

### ART.NO.

C-31	5-406
RAL 9016	5-408

# BSG 2

## 5-405

- / hinge-side protection system (with BU-K\*) for glassdoors
- / architectural, end-to-end solution for standard-compliant protection
- / complete coverage of the belts as well as the counterplates in combination with BU-K\*
- / profile with groove for notching for all common all-glass door hinges
- / simple and fast assembly

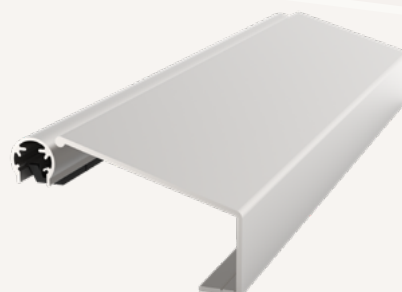
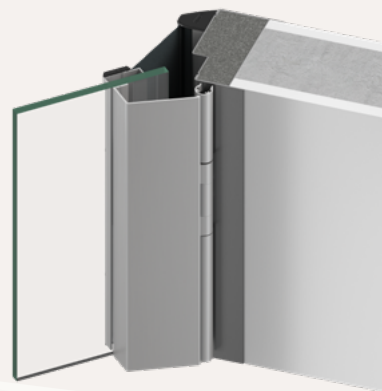

### APPLICATION

Danger point	secondary closing edge, hinge side
Door leaf material	glass
Door frame material	timber, metal
Cleaning	washable

### TECHNICAL DATA

Material profile	aluminium
Surface colors (color profile)	aluminium anodized or color coated, flexible color design possible
Standard colors	C-0, C-31, RAL9016 (special colors optional)
Delivery length	90 mm - 3000 mm
Special lengths available	yes
Standard length	1972 mm

### FIXING

Retrofittable	yes
Mounting	glued
Fixing	glued

### COLORS

COLORS	ART.NO.
C-31	5-407
RAL 9016	5-409

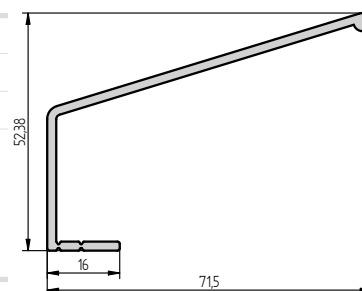

# HS-25

## 5-1001

- / door stop with active finger protection
- / prevention of trapping and shearing points
- / prevents accidental closing of doors
- / permanent protective function through automatic activation
- / manual unlocking possible for both sides of the door



### APPLICATION

Danger point	main closing edge
Door type	flush doors, rebated doors
Free of maintenance	yes
Door leaf material	timber
Door frame material	timber, metal

### TECHNICAL DATA

Material profile	stainless steel
Surface colors (color profile)	stainless steel or color coated, flexible color design possible
Standard colors	C-31, RAL9016, RAL7016 (special colors optional)
Max. door leaf thickness	90 mm

### FIXING

Retrofittable	yes
Mounting	screwed
Diassembly	screwed
Fixing	invisibly screwed

### COLORS

	ART.NO.
C-31	5-1001
RAL 9016	5-1002
RAL 7016	5-1003

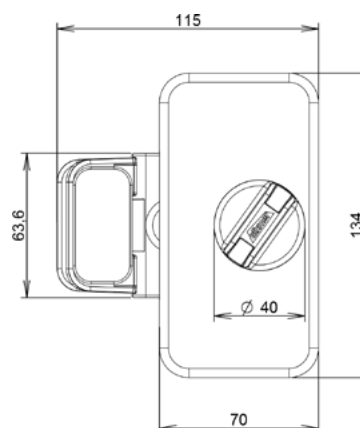







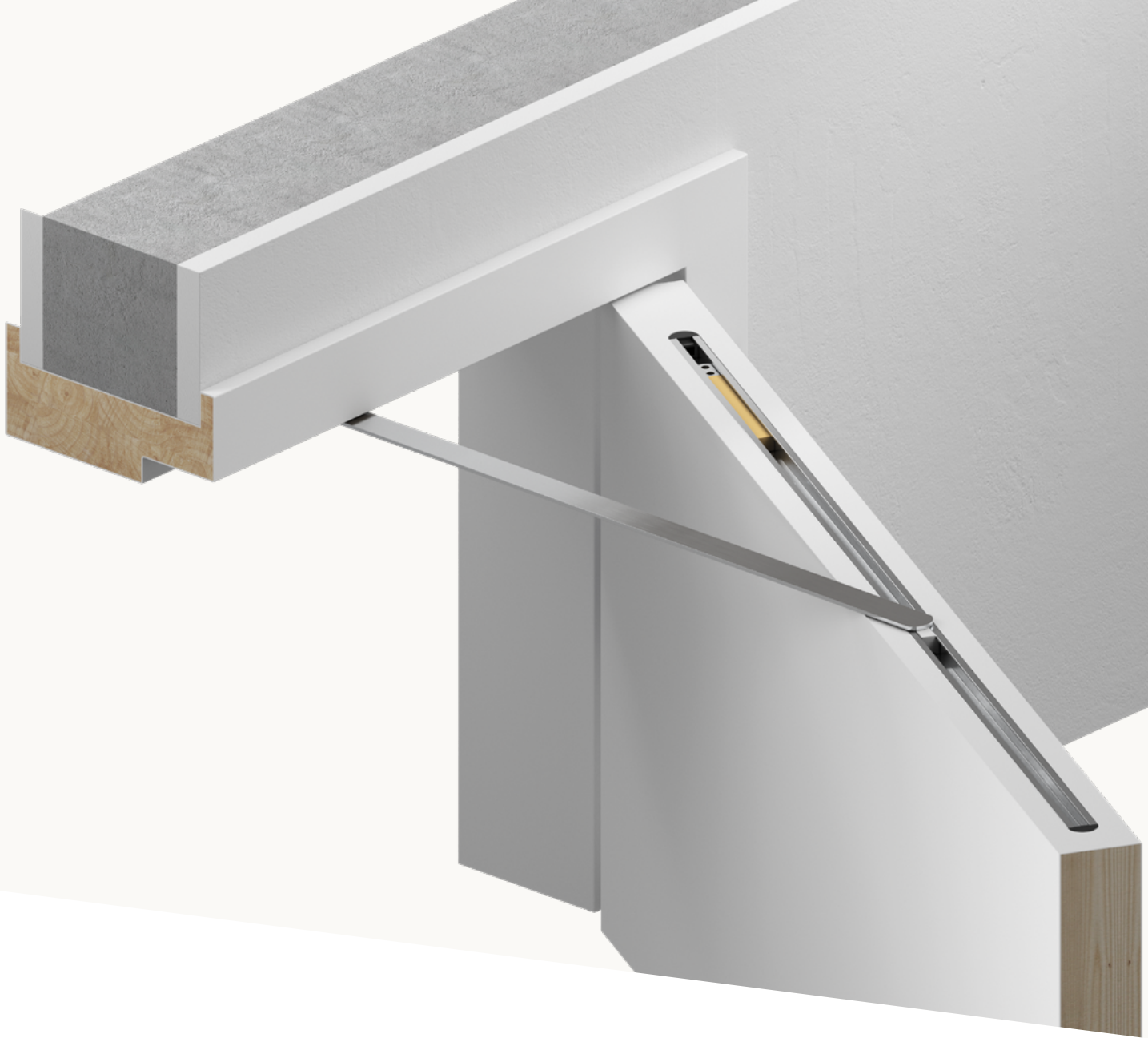

## Door opening restrictor Porti®

- / protects against the dangers of doors slamming open
- / adaptive damping protects door leaf and frame
- / uniquely space-saving, design-oriented
- / easy to install
- / for retrofitting to metal frames
- / avoid stumbling bocks
- / particularly suitable for hygienically and visually demanding areas
- / ideal for use in hotels, offices and doctors' surgeries
- / for floors with underfloor heating, no need to drill holes for door stops in the floor



### Porti® timber doors

### Porti® glass doors

	door leaf width 720 - 1 110 mm			door leaf width 610 - 719 mm			door leaf width 709 - 959 mm		
Frame	metal/ timber*	timber	metal	metal/ timber*	timber	metal	timber	metal	
Door leaf weight up to	30 kg	65 kg	65 kg	30 kg	65 kg	65 kg	50 kg	50 kg	
To retrofit	x		x	x		x		x	
Art.No.	5312	5489	5371	5313	5465	5379	5487	5318	

\* Suitable  
only for  
solid  
timber  
frames

\* Suitable  
only for  
solid  
timber  
frames

CHOOSE YOUR  
**PRODUCT**



# Article name index

Product	Page	Product	Page
AS 2519 S	50	M-12/30 RS	65
AT 07019 V	182	M-12 FS	134
AT 07506	172	M-15/28 OS	75
AT 09019 V	183	M-15/30 EK	73
AT 10006	173	M-15/30 WS	74
AT 12706	174	M-24/20 TS	110
AT 12712 S	178	M-24/20 WS	108
AT 12713	176	M-24/21 OS	109
AT 12713 S	179	Nadi® LM Nadi® FM	44
AT 12713 V	180	NR-25	189
AT 15006	175	NR-32 UniSafe®	188
AT 15213	177	Pivot L-15 (set)	52
BA-28*	203	Porti® glass doors	209
BD-18	200	Porti® timber doors	209
BD-20	201	PS 0402 S	21
BD-23	202	PS 0604 S	24
BO-13	195	PS 0704 S	26
BO-16	196	PS 0704 TE	23
BO-20	198	PS 744 S	38
BO-22	199	PS 788 S	32
BO-23	197	PS 0805 S	27
BR 3506	151	PS 810 TE	40
BR 4911	150	PS 812 TE	41
BS 2906 P	149	PS 1010 P Flex PS 1212 P Flex PS 1515 P Flex	36
BS 3017 V	145	PS 1010 P PS 1212 P PS 1515 P	34
BS 3515 S	144	PS 1108 S	33
BS 4006 S	146	PS 1206 S	22
BS 4807 S	147	PS 1310 S	39
BS 5114 S	148	PS 1817 S	31
BSG1	204	PS 2115 S	20
BSG 2	205	PS 2806 S	51
BU-16K*	190	PS 2807 S	46
BU-18K*	191	PS 2816 S	48
BU-20K*	192	PS 3607 S	47
BU-24K*	194	PS 3645 P	28
Comfort-Plan®	169	PS 3665 P	29
Concealed flush bolt	141	Rainstop® L-24/20 WS	106
Doppeldicht M-12/35	71	RG 7040	184
FB Series	155	RG 7721	185
FF-C Series	158	Schall-Ex® AP 1015 TE	16
FF-D Series	159	Schall-Ex® AP 1018 S	18
FFP-C Series	161	Schall-Ex® AP 1018 TE	17
FFP-D Series	162	Schall-Ex® AP 1019 TE	19
Flush bolt	140	Schall-Ex® Applic A	136
FPP Series	160	Schall-Ex® GS-A	126
FP Series	156	Schall-Ex® GS-H8/12	128
F Series	154	Schall-Ex® GS-H10	127
HS-25	206	Schall-Ex® Jumbo I	111
Isolporte Omega	70	Schall-Ex® Jumbo II	138
Isolporte Standard	69	Schall-Ex® Jumbo III	139
L-15/35 OS	82	Schall-Ex® L-8/30 WS	62
L-15/38 WS	81	Schall-Ex® L-14/35 EK	72
M-12/12 RS	63	Schall-Ex® L-15/30 EK	78
M-12/20 RS	64	Schall-Ex® L-15/30 OS	80
M-12/28 OS	67	Schall-Ex® L-15/30 WS	79
M-12/30 EK	68	Schall-Ex® L-15 FS	137



<b>Product</b>	<b>Page</b>	<b>Product</b>	<b>Page</b>
Schall-Ex® L-15 Pivot	123		
Schall-Ex® Radiation Protection OS	87		
Schall-Ex® Radiation Protection OS BD	88		
Schall-Ex® Radiation Protection WS	85		
Schall-Ex® Radiation Protection WS BD	86		
Schall-Ex® Slide GS-A	130		
Schall-Ex® Slide GS-H10	131		
Schall-Ex® Slide & Lock L-24/20 WS	116		
Schall-Ex® Slide & Lock M-12 WS	115		
Schall-Ex® Slide M-12 WS	114		
Schall-Ex® Slide Radiation Protection M-20 OS	122		
Schall-Ex® Slide Radiation Protection M-20 WS	121		
Schall-Ex® Ultra	83		
Schall-Ex® Ultra OS	84		
Sili II	25		
Slide L-15/38 WS	117		
Slide M-24/20 TS	120		
Slide M-24/20 WS	118		
Slide M-24/21 OS	119		
Slide VN 8/10	59		
Stadi L-17/20 WS	94		
Stadi L-20/20 OS	98		
Stadi L-20/20 WS	96		
Stadi L-24/20 OS	102		
Stadi L-24/20 TS	104		
Stadi L-24/20 WS	100		
Stadi LD-17/20 WS	95		
Stadi LD-20/20 OS	99		
Stadi LD-20/20 WS	97		
Stadi LD-24/20 OS	103		
Stadi LD-24/20 TS	105		
Stadi LD-24/20 WS	101		
Stadi M-17/17 WS	92		
Stadi MD-17/17 WS	93		
Stadi XL-40 ST	107		
Thresholds	170		
Unitherm FAS-20	49		
Universal M-12 (set)	54		
VHH M-12 (set)	56		
Wind Ex S	135		
ZD Slide 12/12	58		
ZD Universal	30		

# Article number index

Product	Page	Product	Page
1-147	70	1-751	146
1-153	69	1-752	147
1-154	111	1-753	147
1-157	139	1-755	67
1-169	82	1-814 silver-coloured, anod. C-0	126
1-172	81	1-815	126
1-177	117	1-817 silver-coloured, anod. C-0	128
1-178	75	1-818	128
1-179	75	1-839	56
1-184	74	1-875 silver-coloured, anod. C-0	130
1-185	74	1-876	130
1-244	109	1-880	79
1-248	110	1-881	80
1-264	108	1-884 silver-coloured, anod. C-0	137
1-290	83	1-885	137
1-291	83	1-888	137
1-292	84	1-935	72
1-293	84	1-937	92
1-294	87	1-938	100
1-295	87	1-939	96
1-382	79	1-940	94
1-392	71	1-946	123
1-453	127	1-950	93
1-453 silver-coloured, anod. C-0	127	1-951	101
1-454	127	1-952	97
1-471	119	1-953	95
1-472	120	1-955	106
1-473	118	1-959	102
1-474	138	1-960	104
1-477	107	1-965	116
1-519	88	1-972	98
1-520	88	1-985	99
1-521	86	1-1000	62
1-522	86	1-1013	55
1-528	85	1-1014	55
1-529	85	1-1015	55
1-548	114	1-1016	55
1-549	115	1-1017	78
1-554	122	1-1024	135
1-557	121	1-1025	103
1-572 silver-coloured, anod. C-0	131	1-1026	105
1-658 silver-coloured, anod. C-0	136	1-1079	149
1-668	136	3-100	170
1-669	136	3-103	170
1-676	127	3-104	170
1-677	127	3-107	170
1-681	131	3-108	170
1-723	64	3-111	170
1-725	65	3-114	170
1-726	68	3-117	170
1-740	73	3-120	170
1-741	73	3-135	170
1-742	134	3-150	170
1-743	134	3-152	170
1-744	63	3-201	178
1-747	134	3-202	179
1-749	73	3-278	169
1-750	146	3-288	169

<b>Product</b>	<b>Page</b>	<b>Product</b>	<b>Page</b>
5-101	189	5-458	195
5-104	189	5-459	200
5-109	189	5-469	199
5-112	203	5-493	198
5-113	203	5-494	197
5-114	203	5-495	202
5-185	189	5-499	189
5-231	197	5-901	188
5-242	197	5-904	188
5-250	202	5-909	188
5-261	201	5-985	188
5-262	201	5-999	188
5-263	201	5-1001	206
5-269	201	8-101	50
5-303	202	8-111	46
5-310	190	8-112	46
5-311	190	8-113	47
5-312	190	8-114	47
5-313	190	8-115	48
5-314	196	8-116	48
5-315	196	8-119	51
5-316	197	210	58
5-317	196	523	59
5-318	196	1502-1187	141
5-320	191	1502-1217	141
5-321	191	1502-1487	141
5-321	191	1502-1517	141
5-322	191	1651	140
5-330	192	1652-2	140
5-331	192	1653	140
5-331	192	1792	140
5-332	192	150002	25
5-341	193	319204	49
5-343	193	370300	30
5-344	193	371300	30
5-348	194	F160052	156
5-350	194	F160053	156
5-351	194	F160054	156
5-353	194	F160055	156
5-354	202	F160056	156
5-404	204	F160057	156
5-405	205	F160058	156
5-406	204	F160059	156
5-407	205	F160060	156
5-408	204	F160061	156
5-409	205	F160062	156
5-445	198	F160062	156
5-446	198	F160063	156
5-447	198	F160064	156
5-449	200	F160065	156
5-450	200	F160065	156
5-451	200	F160066	156
5-452	199	F160067	155
5-453	199	F160068	155
5-454	199	F160069	155
5-455	195	F160069	155
5-456	195	F160070	155
5-458	195	F160071	155

# Article number index

Product	Page	Product	Page
F160072	155	F160135	160
F160073	155	F160137	160
F160074	155	F160140	165
F160075	155	F160141	158
F160076	159	F160142	158
F160077	159	F160143	158
F160078	159	F160144	158
F160079	159	F160145	158
F160080	159	F160146	158
F160081	159	F160147	158
F160082	159	F160148	158
F160083	159	F160150	156
F160084	159	F160151	156
F160085	154	F160152	156
F160086	154	F160153	156
F160087	154	F160154	160
F160088	154	F160155	160
F160089	154	F160156	160
F160090	154	F160157	160
F160091	154	F160158	160
F160092	154	F160159	160
F160093	154	F160160	160
F160095	154	F160161	160
F160096	154	F160162	160
F160097	154	F160163	160
F160098	154	F160164	160
F160099	154	F160165	161
F160100	154	F160166	161
F160101	154	F160167	161
F160102	154	F160168	161
F160103	154	F160169	161
F160104	154	F160170	161
F160105	154	F160171	162
F160105	156	F160172	162
F160106	156	F160173	162
F160107	156	F160174	161
F160108	156	F160175	161
F160109	156	F160176	161
F160110	155	F160177	162
F160111	155	F160178	162
F160112	155	F160179	162
F160113	159	F160180	162
F160114	159	F160181	162
F160115	159	F160182	162
F160116	154	F160183	158
F160117	154	F160184	158
F160118	154	F160185	158
F160119	154	F160186	158
F160120	154	F160198	157
F160121	154	F160199	157
F160122	154	F160200	157
F160122	156	F160201	157
F160125	157	F160209	158
F160127	157	F160215	156
F160133	160	F160216	156
F160134	160	F160218	156

<b>Product</b>	<b>Page</b>	<b>Product</b>	<b>Page</b>
F160219	156	P160009	19
F160220	156	P160010	19
F160222	156	P160011	19
F160223	156	P160012	19
F160224	156	P160027	21
F160225	156	P160028	21
F160226	156	P160029	21
F160227	156	P160030	24
F160228	155	P160031	24
F160230	155	P160032	24
F160231	155	P160033	27
F160232	155	P160034	27
F160233	155	P160035	27
F160234	155	P160036	28
F160235	155	P160040	32
F160236	155	P160041	32
F160237	155	P160041	32
F160238	155	P160042	32
F160239	155	P160043	34
F160240	155	P160044	34
F160241	155	P160045	34
F160242	155	P160046	34
F160243	155	P160047	34
F160273	158	P160048	34
F160274	158	P160049	34
F160275	158	P160050	34
F160276	158	P160051	34
F160277	158	P160056	26
F160278	158	P160057	26
F160279	158	P160058	29
F160280	158	P160059	40
F160281	158	P160060	40
F160282	158	P160061	40
F160283	158	P160062	41
F160284	158	P160063	41
F160285	158	P160064	41
F160286	158	P160065	26
F160287	158	P160066	40
F160288	158	P160069	16
F160289	157	P160070	16
F160290	158	P160071	16
F160291	158	P160072	16
F160292	158	P160076	164
F160293	158	P160077	164
F160294	158	P160078	32
F160295	158	P160080	26
F160296	158	P160084	174
F160297	157	P160086	176
P160001	18	P160087	180
P160002	18	P160090	177
P160003	18	P160092	175
P160004	18	P160094	144
P160005	17	P160100	148
P160006	17	P160102	38
P160007	17	P160103	38
P160008	17	P160104	38

# Article number index

Product	Page	Product	Page
P160105	38	P160226	33
P160111	39	P160227	33
P160112	39	P160228	33
P160113	39	P160229	33
P160114	39	P160230	33
P160122	151		
P160123	184		
P160124	185		
P160130	36		
P160131	36		
P160132	36		
P160135	36		
P160136	36		
P160137	36		
P160138	36		
P160139	36		
P160140	36		
P160141	20		
P160142	20		
P160143	20		
P160144	20		
P160145	31		
P160146	36		
P160147	36		
P160148	22		
P160149	22		
P160150	22		
P160151	36		
P160155	29		
P160156	28		
P160159	36		
P160160	36		
P160161	36		
P160187	31		
P160188	31		
P160196	145		
P160197	172		
P160198	173		
P160199	182		
P160200	183		
P160202	150		
P160203	23		
P160204	23		
P160205	23		
P160206	23		
P160207	23		
P160208	23		
P160209	36		
P160210	36		
P160211	36		
P160216	32		
P160217	32		
P160221	22		
P160222	22		
P160223	22		
P160225	33		



**Product**

**Page**

# Installation information

## AUTOMATIC DROP SEALS

### HINGED TIMBER, SYSTEM & GLASS DOORS

- / Fixing: in the groove
  - single actuation, hinge side
  - double actuation, hinge & lock side
  - single actuation, lock side

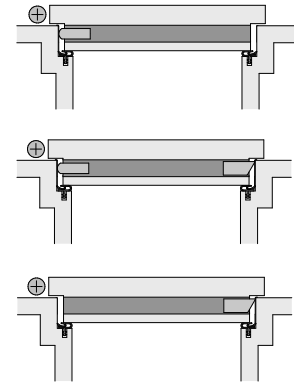

- / Fixing: surface mounted
  - single actuation, hinge side
  - single actuation, hinge side with angle pressure bracket
  - single actuation, hinge side

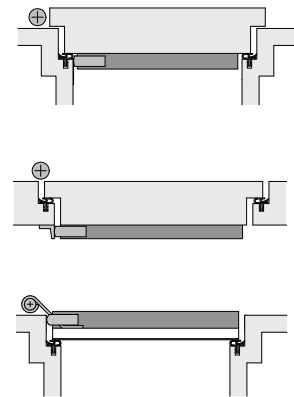

- / Fixing: bonded to underside
  - single actuation, hinge side
  - double actuation, hinge & lock side

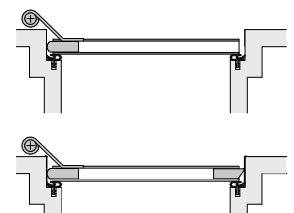

### SLIDING TIMBER, SYSTEM & GLASS DOORS

- / Fixing: in the groove
  - single actuation, lock side

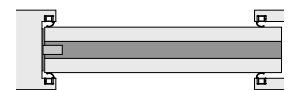

- / Fixing: surface mounted
  - single actuation, lock side



- / Fixing: bonded to underside
  - single actuation, lock side



# Glossary of terms

## AUTOMATIC DROP SEALS

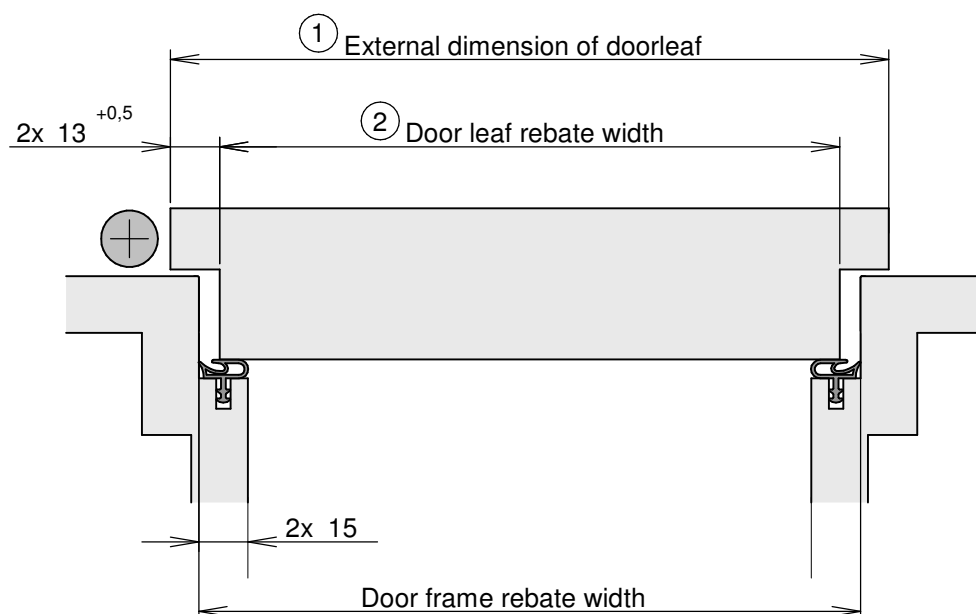

## PRODUCT NAMES

e.g. Schall-Ex® **L-15/30 WS**

TRAVEL	GROOVE DIMENSION (MM)	FIXING
M- medium travel	15 - groove width	EK - end caps
L- large travel	30 - groove depth	WS - fixing brackets
MD- medium travel, delayed drop		OS - omega-shaped profile (screw under)
LD- large travel, delayed drop		TS - T-shaped profile (screw under)
		RS - screw through the sealing rubber
		FS - surface mounted

# Glossary of terms

## **ACTUATION**

The motion a drop seal makes when it's sealing profile drops to the floor.

## **ACTUATOR**

Drop seal component that protrudes from one or both sides of a door and is compressed by contact with the door frame. Upon compression it activates the inner rail and sealing profile, pushing them towards the floor.

## **AUTOMATIC DROP SEAL**

An item of door hardware located at the bottom of a door, typically made from aluminium with built-in spring mechanism. It contains a sealing profile gasket typically made from silicone, which drops automatically upon door closing to form a seal with the floor by sealing the gap at the bottom and retracts upon door opening.

## **BACKSET**

An ironmongery term to describe the distance between the door edge and the specified part of a door hardware item, e.g. the centre of the bolt on a flush bolt or the centre of the spindle on a door lock.

## **DELAYED DROP**

An athmer technology available with selected drop seals. It delays actuation of the seal for 6-8 seconds after the door closes. A delay in actuation will prevent pressure changes from affecting the door operation. This feature is particularly useful in positive-pressure environments, a growing application in hospitals and biosafety labs

## **DOUBLE ACTUATION**

An athmer technology available with selected drop seals. These models have an additional actuator on the latch side of the door, spreading actuation pressure more evenly over the door. This feature is particularly useful with wide doors and supports long-term durability.

## **FIRE DOOR**

An engineered life safety device. Fire door is a term often used to describe a full fire door assembly including the door leaf, frame and essential hardware, which has been designed to resist fire for a specific period of time.

## **GRAPHITE-BASED INTUMESCENT**

A general term for intumescent made from intercalated graphite, one of the three main types of intumescent material. Common characteristics of graphite-based intumescent include an aggressive multidirectional expansion, production of a light, fluffy material and an initial activation temperature of around 200°C.

## **HEAD & JAMBS**

The two types of component that together make up a door frame. The jambs are vertical members positioned at each side of a door opening. The head is a horizontal member positioned at the top of a door opening.

## **INNER RAIL**

Drop seal component used to hold the sealing profile typically made from aluminium. It is contained within the main outer housing and drops to the floor during seal actuation.

## **INTERDENS®**

A specific brand of phosphate-based intumescent material, a registered trademark of BASF Wolman GmbH, Sinzheim, Germany.

## **INTUMESCENT SEAL**

A seal that becomes active when subjected to elevated temperature and impedes the flow of heat, flame or gases. Upon activation it expands to fill gaps and voids in a fire resistant structure, for example a fire door assembly. Sometimes referred to as a fire seal.

## **MEETING STILE**

The gap where a pair of doors meet.

### **OVERLOAD PROTECTION**

An athmer technology present in selected drop seals that automatically detects when the sealing profile has dropped far enough and cuts off further actuation pressure. Overload protection ensures a consistent, even seal and protects the seal's components from excessive pressure.

### **PALUSOL®**

A specific brand of silicate-based intumescent material, a registered trademark of BASF Wolman GmbH, Sinzheim, Germany.

### **PARALLEL DROP**

An athmer technology incorporated in selected drop seals that drops the sealing profile evenly on both sides of the door. Parallel drop prevents seal dragging and supports long-term durability.

### **PERIMETER SEAL**

A flexible seal used to seal the head & jambs of a door frame. Sometimes referred to as a frame seal. It can be rebated or fixed with self-adhesive tape.

### **PHOSPHATE-BASED INTUMESCENT**

A general term for intumescent made from mono ammonium phosphate, one of the three main types of intumescent material. Common characteristics of phosphate-based intumescent include an almost pressureless multidirectional expansion, production of a sticky meringue-like foam and an initial activation temperature of around 150°C.

### **PRESS PLATE**

A thin metal plate often supplied with our drop seals, used to prevent damage to door frames. They are supplied as an accessory to our drop seals.

### **PVC (POLYVINYL CHLORIDE)**

A synthetic plastic polymer that can be extruded in both rigid and flexible forms for a variety of uses.

### **PVC-ENCASED INTUMESCENT SEAL**

A common type of intumescent seal that consists of an intumescent material covered by a protective PVC casing.

### **SELF-EXTINGUISHING, FLAME-RETARDANT SILICONE**

A type of elastomer (rubber) containing silicone, which when set alight will extinguish flames by itself. Standards available to test the performance of this type of material include UL 94.

### **SILICATE-BASED INTUMESCENT**

A general term for intumescent made from hydrated sodium silicate, one of the three main types of intumescent material. Common characteristics of silicate-based intumescent include a uniaxial expansion, production of a solid foam and an initial activation temperature of around 110-120°C.

### **SLIDING ACTUATOR**

A particular type of actuator developed by athmer and made from a technical nylon material, designed to 'slide' across door frame surfaces. This type of actuator reduces friction with the door frame, protecting both the actuator and door frame from long-term wear.

### **TPE (THERMOPLASTIC ELASTOMER)**

A type of copolymer (usually a mix of plastic and rubber) that consists of materials with both thermoplastic and elastomeric properties.

### **WORKING TEMPERATURE**

The temperature range within which a seal will function correctly and as described. Sometimes referred to as operating temperature.

# Standards

## **BS 476-22**

Method for determination of the fire resistance of non-loadbearing elements of construction (British standard)

## **DIN 18095-2**

Type testing for durability and leakage of smoke control doors

## **DIN 4102-18**

Fire behaviour of building materials and components; fire barriers, verification of automatic closure (continuous performance test)

## **EN 1026**

Test method – air permeability of windows and doors

## **EN 1027**

Test method – water tightness of windows and doors

## **EN 1191**

Test method for resistance to repeated opening and closing of windows and doors

## **EN 12207**

Classification – air permeability of windows and doors

## **EN 12208**

Classification – water tightness of windows and doors

## **EN 12210**

Classification – resistance to wind load of windows and doors

## **EN 16005**

Requirements and test methods for power operated pedestrian doorsets

## **EN 1628**

Test method – determination of resistance under static loading of pedestrian doorsets, windows, curtain walling, grilles and shutters

## **EN 1629**

Test method – determination of resistance under dynamic loading of pedestrian doorsets, windows, curtain walling, grilles and shutters

## **EN 1630**

Test method – determination of resistance to manual burglary attempts of pedestrian doorsets, windows, curtain walling, grilles and shutters

## **EN 1634-1**

Fire resistance test for door and shutter assemblies, openable windows and elements of building hardware.

\*The test value may differ according to the EN 1634-1 test, as the complete door system must be checked.

## **EN 1634-3**

Smoke control test for door and shutter assemblies, openable windows and elements of building hardware

## **EN 1670**

Requirements and test methods for corrosion resistance of building hardware



**DIN 18040-1**

Design principles for construction of accessible buildings – publicly accessible buildings

**DIN 18040-2**

Design principles for construction of accessible buildings – dwellings

**DIN 18040-3**

Design principles for construction of accessible buildings – public circulation areas and open spaces

**EN ISO 717-1**

Rating of sound insulation in buildings and of building elements – airborne sound insulation

**EN ISO 10140-1**

Laboratory measurement of sound insulation of building elements – application rules for specific products

**EN ISO 10140-2**

Laboratory measurement of sound insulation of building elements – measurement of airborne sound insulation

**EN ISO 10140-3**

Laboratory measurement of sound insulation of building elements – measurement of impact sound insulation

**EN ISO 10140-4**

Laboratory measurement of sound insulation of building elements – measurement procedures and requirements

**EN ISO 10140-5**

Laboratory measurement of sound insulation of building elements – requirements for test facilities and equipment

Headquarter, Germany  
**athmer oHG**  
Sophienhammer  
+49 2932 477 500

**info@athmer.com**

**Middle East, Dubai, UAE**  
athmer Middle East BMT LLC  
+971 4 346 3800

**dubai@athmer.com**

**South Asia, Pune, India**  
Athmer South Asia Pvt Ltd  
+91 9962 5072 72

**sa@athmer.com**

**Southeast Asia, Singapore**  
Athmer Southeast Asia Pte. Ltd.  
+65 9838 3252

**sea@athmer.com**

**Asia, Qingdao, China**  
Qingdao Sophienhammer Hardware Co., Ltd.  
+86 532 8098 1098

**info@athmer.cn**



Follow us on WeChat

**athmer**